

Accessories

For a full list of optional extras and accessories for your product please see Page 7.

To order accessories or spares please contact either your supplier
or Smith's Environmental Products Ltd.

Technical designation: Caspian Skyline® CT60 EC

Products with this symbol (crossed out wheelie bin) cannot be disposed as household waste. Old electrical and electronic equipment must be recycled at a facility capable of handling these products and their waste by-products. If you are purchasing replacement equipment your retailer may offer a 'take back' scheme, or will be able to give details of the nearest approved authorised treatment facility. Proper recycling and waste disposal will help conserve resources whilst preventing detrimental effects on our health and the environment.

WEEE Registered Code : WEE/ED0093VW

In the event of any items missing or visible damage, please contact us on 01245 324560.



Smith's Environmental Products Ltd

Blackall Industrial Estate, South Woodham Ferrers, Chelmsford, Essex, CM3 5UW

Tel: 01245 324900 Fax: 01245 324422

Sales: sales@SmithsEP.co.uk General Information E-mail: info@SmithsEP.co.uk Web: www.SmithsEP.co.uk

For Ireland (Republic & Northern), contact MT Agencies on 00 353 1 864 3363

In light of our policy of continuous development Smith's Environmental Products Ltd reserve the right to alter specifications without prior notice.



CASPIAN SKYLINE® CT60 EC

Ceiling Level Fan Convector

Suitable for Installation within a ceiling void

Installation & User Guide



User Information:

- This appliance can be used by children aged from 8 years and above and persons with reduced physical, sensory or mental capabilities or lack of experience and knowledge if they have been given supervision or instruction concerning use of the appliance in a safe way and understand the hazards involved. Children shall not play with the appliance. Cleaning and user maintenance shall not be made by children without supervision
- A means for disconnection from the supply mains having a contact separation in all poles that provides full disconnection under overvoltage category III conditions must be incorporated in the fixed wiring in accordance with the wiring rules.
- Ensure that the fan convector is switched-off before opening the cover.

Introduction

This heater is designed to be installed into suspended T-bar and plasterboard ceilings (The minimum height of the void into which the unit will be installed should be a minimum of 250mm). The weight of the heater is **19Kg**. The fixing means for attachment to the ceiling such as hooks or other devices shall be fixed with sufficient strength to withstand 4 times the weight of the ceiling heater.

User Information:

This heater must not be installed in wet rooms or other high humidity areas. This heater is designed for use on standard two-pipe pumped central heating systems with a maximum water temperature of 86° C and a maximum pressure of 6 bar (88lbs/in²). Pipe connections are 22mm and either pipe may be used as flow or return.

This heater is classified as a fixed appliance and the electrical connection should be via a 3A fused spur. The fused spur must **not** be directly below the heater but should be accessible after completion of the installation. This heater must be earthed. It is recommended that this heater is wired via a remote room thermostat.

To avoid the possibility of vibration this heater must be fitted to a flat even surface.

This heater is fitted with a 35°C Low Limit Stat (L.T.C).

To conform to Building Regulations Part L (Part J in Scotland), a remote room thermostat can be used in conjunction with this heater. Refer to the instructions supplied with the thermostat.

Please note the guarantee may be invalidated if this product is not installed and used in accordance with these instructions.

For further details please contact our Technical Support on 01245 324560.

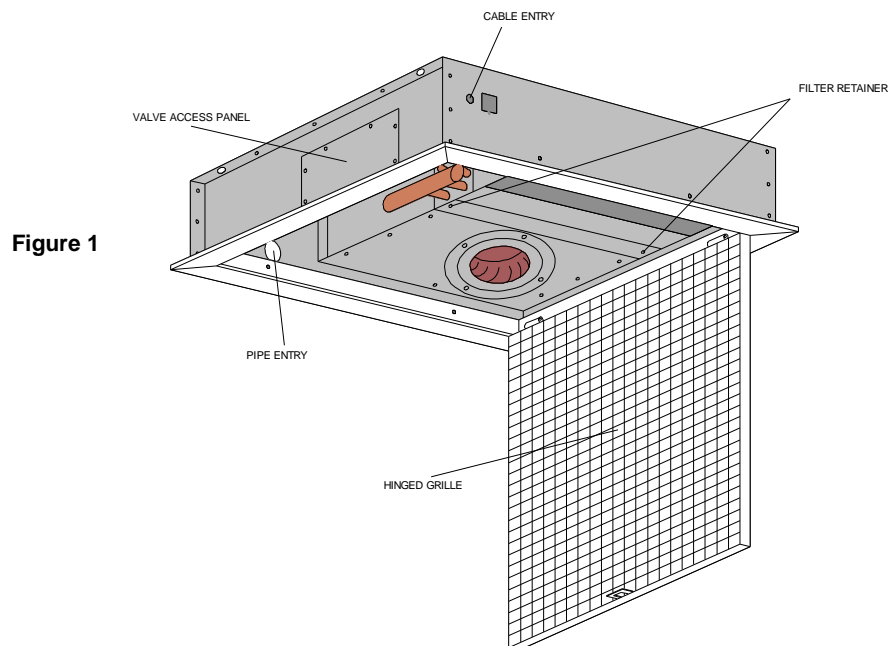

Figure 1

Optional Accessories

Optional accessories are available to offer additional control or functionally not offered by the heater in its standard configuration.

<u>Electrical Accessories</u>	
<u>External Control Harness</u> Allows for the standard unit controller to be relocated externally from the heater.	<u>EXTCH</u>
<u>Adjustable low temperature cut-out</u> This enables the end user to precisely select the temperature at which the fans will switch on when combined with different heat sources.	<u>UVCALTC T3</u>
<u>Miscellaneous Accessories</u>	
<u>Caspian 22mm Flexible Hoses</u>	<u>CAS22FH</u>
Replacement air filters.	
For accessories or spares please contact either your supplier or Smith's Environmental Products Ltd.	

2

Fault Finding

- 1) **The fan does not run on any switch setting.**
 - a) Check the power supply is switched ON.
 - b) Check the fuse in the fused spur.
 - c) Check the wiring at the fused spur.
- 2) **No heat output.**
 - a) Vent any trapped air from the system (with the heating system turned OFF).
 - b) Check the central heating is switched ON.
 - c) If a thermostat is fitted ensure it is calling for heat.
 - d) Balance the central heating system if installed on the same circuit as panel radiators and increase the circulating pump speed if required.
 - e) Increase the boiler water temperature.

In the event of difficulty please contact our technical help-line on 01245 324560. It will be helpful if you do not disconnect the heater from the central heating system.

Information and advice

A product brochure containing full technical specifications and list prices is available to download from our website or in hard copy from our office. Also available on our website are price lists, individual product datasheets, installation & user guides, where to buy, who to contact and a media centre.

Alternatively contact our office 9.00am to 5.00pm Monday to Thursday, 9.00am to 4.00pm on Friday.

7

Commissioning

Ensure the central heating system is **ON**. Providing the water temperature in the central heating system is more than 35°C and the thermostat (if fitted) is calling for heat the product will switch on.

- 1) Turn on the electrical supply to the unit at the fused spur.
- 2) Turn on the central heating system.
- 3) Turn the thermostat control (if fitted) to the maximum.
- 4) If the heater is installed on the same circuit as panel radiators balance the central heating system.
- 5) Adjust the fan speed to the preferred setting by adjusting the controller (turn left to reduce speed and right to increase)
- 6) If the installation is working correctly remember to reset the thermostat control (if fitted) to its normal setting.

If your heater does not operate refer to "Fault Finding" on page 7.

Maintenance

Warning! Isolate from the electrical supply before servicing.

The heater is fitted with a replaceable air filter. To remove the filter, lower the hinged grille, loosen the two screws securing the filter retainer (See Figure 1), slide the across to give access and remove the filter, replacing the air filter is the reverse of removing it. The filter can be gently tapped or vacuumed to remove any accumulated dust if necessary (approx. every 6 months). We recommend replacing the filters approx. every 2 years depending on environmental condition.

The filter is not covered by Smith's 5 Year Guarantee.

The heat exchanger should be cleaned with a soft brush or vacuum to remove any dust that may have accumulated, care must be taken not to damage the delicate heat exchanger fins.

The fan(s) and motors should not require servicing. Please contact your supplier if damaged.

Please note in the event of an engineer's visit, Smith's Environmental Products Ltd reserve the rights to apply a call-out charge should the fault prove to be with the system or installation and not the heater appliance.

Preparation

The following items should be included in the carton:

- Caspian Skyline® CT60 EC unit.
- Grille.
- Installation & User Guide.
- X4 No 8 Screws.

Other items required for a successful installation:

- Three core mains cable.
- Isolating valves (Failure to fit isolating valves may mean that the product is not serviceable in the event of failure).
- Air Vent/ Bleed valve.
- Suitable mounting hardware (Such as chains, threaded rod etc).

Accessories including replacement air filters are available (See page 7).

In the event of any items missing or visible damage, please contact us on 01245 324560, before continuing with the installation.

Installation

This heater should be mounted at a minimum height of 1.8m (To the underside of the grille) and a maximum height 4m

Installation into a suspended T Bar ceiling

Figure 2

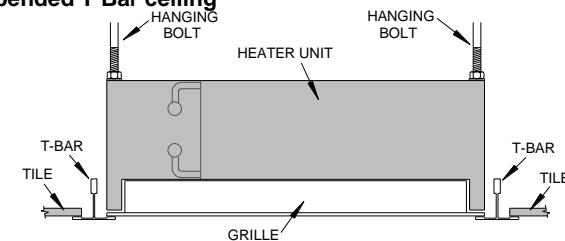

- 1) Choose the position in the ceiling grid that the heater is to be installed and remove the chosen ceiling tile, as well as any surrounding tiles to provide adequate access during installation.
- 2) Ensure suitable means of support such as threaded rods or chains are used and fixed into place directly above the chosen grid position.
- 3) Lift the heater through the T bar grid into the void and securely attach the supports to the heater.
- 4) Lift the grille into the grid and adjust the heater so that they meet together.
- 5) Drill four holes (two in each side) 3mm (1/8") holes and secure with the provided screws (See fig. 4). Once secured the grille can be opened and closed by pushing against the grille on the side with the closure (Once to open, Once again to close), care should be taken not to bend the grille.
- 6) Proceed to page 5 for plumbing and electrical connection.

Installation into a plasterboard ceiling

Figure 3

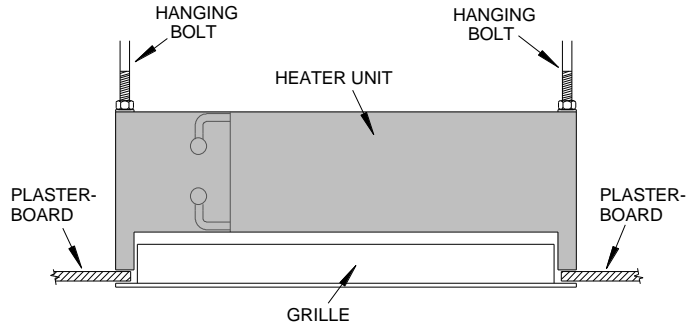

Note: Access to the ceiling void, other than the heater cut-out must be available for installation for plumbing, electrical connection and maintenance.

- 1) Cut a square hole 575mm x 575mm into the plasterboard and ensure that any obstructions are a minimum of 210mm away from the heater.
- 2) Ensure suitable means of support such as threaded rods or chains are used and fixed into place directly above the chosen installation cut-out.
- 3) Lift the heater through the cut-out into the void and securely attach the supports to the heater.
- 4) Lift the grille into the cut-out and adjust the heater so that they meet together.
- 5) Drill four holes 3mm (1/8") holes (two in each side) and secure with the provided screws (see figure 4). Once secured the grille can be open and closed by pushing against the grille on the side with the closure (Once to open, Once again to close), care should be taken not to bend the grille.
- 6) Proceed to page 5 for plumbing and electrical connection.

Figure 4

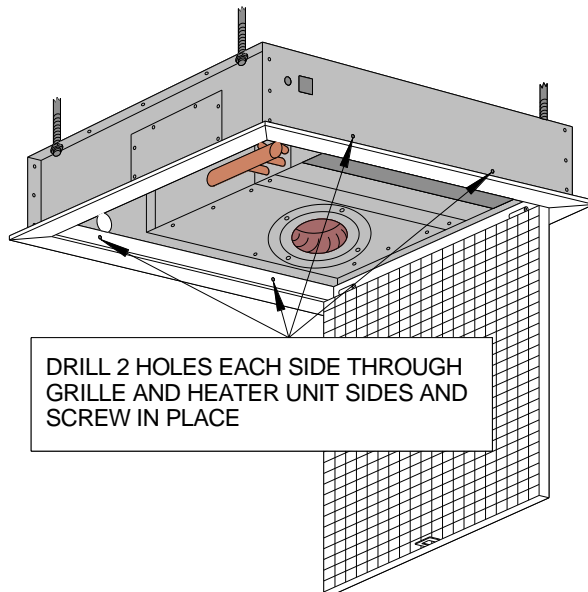

Plumbing connection

Pipe connections to the heat exchanger should be made using 22mm pipe and fittings, Isolating valves should be fitted to ensure the product is serviceable in the future. It is advisable to use flexible hoses to reduce vibration (available as an accessory, see page 7). An air vent must also be fitted to the system pipework above the highest point of the product.

Pipe entry should be made through the entry holes in the end of the heater (shown in fig 1). Isolating/ Service valves may be installed within the heater casing, a removable panel in the side of the heater allows valves to be adjusted however additional access to the void space must be available (in a T-Bar ceiling an adjacent removable tile would suffice however in plasterboard ceiling access would have to be considered before installation).

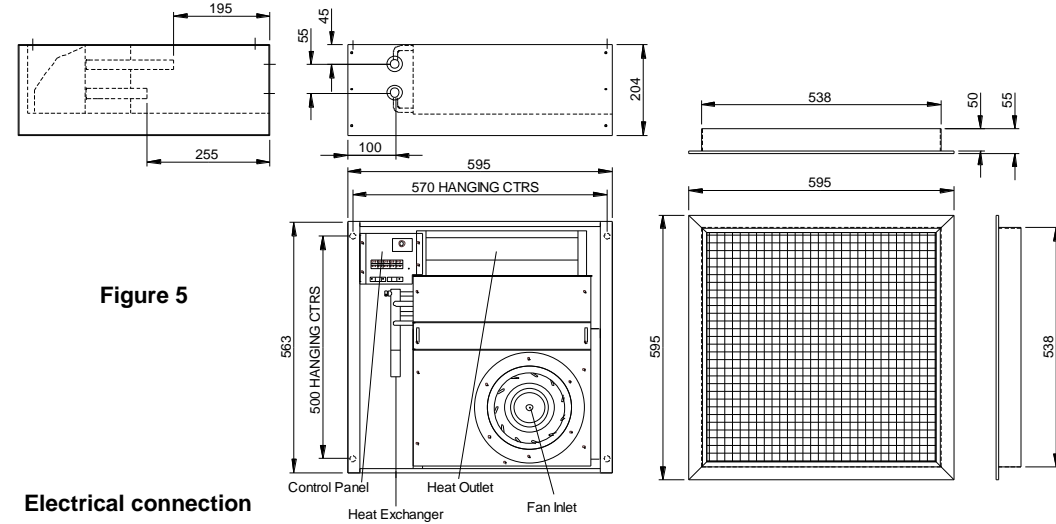

Figure 5

Electrical connection

Unscrew and remove the electrical panel, connect the fused spur to the terminal block in the unit using suitable 3 core cable (see wiring diagram below).

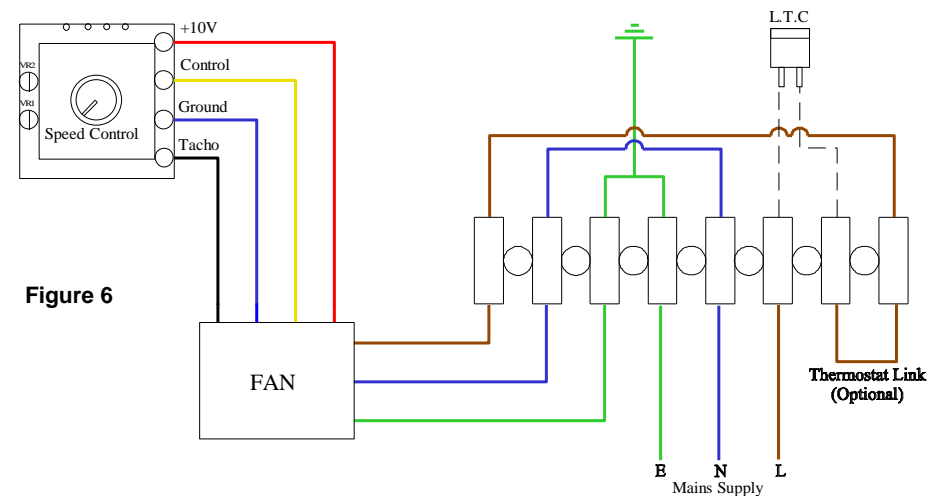

Figure 6

Guarantee Statement

Thank you for purchasing a Smith's heater.

It has been designed and manufactured to the highest quality standards to ensure it gives you efficient and trouble-free service for many years.

To back up our commitment, included with your product is a **free five year parts and labour guarantee** (excludes filters if fitted).

This gives you peace of mind that in the unlikely event of the product failing within the first five years, we will repair or replace the product completely free of charge provided the product has been installed, used and maintained in accordance with the instructions.

It is important to register within 7 days. This will ensure you receive a prompt and efficient service, if your product requires attention within the guarantee period. If you do not register your product, you will be required to produce a proof of purchase prior to receiving this service.

If you experience any problems with the use of your product, please contact our **after-sales office** on 01245 324560.

Smith's Environmental Products Ltd manufactures a complete range of heaters for domestic and commercial applications.

If you require any further information, please contact us on **01245 324900** or visit our website at **www.SmithsEP.co.uk**

Your statutory rights are not affected by this guarantee.

Please pull this Registration card from the booklet and fill in all parts and return.



please fold along here

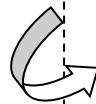

Smith's Environmental Products Ltd
Units 1 & 2 Blackall Industrial Estate
Hamberts Road
South Woodham Ferrers
Chelmsford
Essex
CM3 5UW

**Please
affix
stamp
here**

**Guarantee Registration Card
& Customer Satisfaction Survey**

Dear Customer

We hope our product suits all your requirements; it would help us immensely if you could find the time to fill in this form, your response will help us maintain the quality standards we all expect in today's climate.

Customer name _____ Date ____/____/____

Email Address _____@_____

Product Name _____

Tick as appropriate

	V Good	Good	Fair	Poor
Product	<input type="checkbox"/>	<input type="checkbox"/>	<input type="checkbox"/>	<input type="checkbox"/>
Delivery	<input type="checkbox"/>	<input type="checkbox"/>	<input type="checkbox"/>	<input type="checkbox"/>
Sales & Ordering	<input type="checkbox"/>	<input type="checkbox"/>	<input type="checkbox"/>	<input type="checkbox"/>
Response to any problems	<input type="checkbox"/>	<input type="checkbox"/>	<input type="checkbox"/>	<input type="checkbox"/>

Comments _____

Thank you for your time to fill in this survey, the response will help us to serve your needs more effectively. Please return by fax to 01245324422.

Quality Control Manager: Ron Brown ron.brown@smithsep.co.uk

User Details

User Name Mr/Mrs/Miss/Ms/Other

Initials Surname

Address

.....

..... Post Code:

Telephone:

Product & Model installed (e.g. Space Saver SS5)

Room Installed (e.g. Kitchen):

Your details will only be held by Smiths Environmental Products Ltd and used solely to provide customer services and product information.
 If you do not wish to be contacted, please put an x in the box.

Installer Details

Company name:

Principal contact: Mr/Mrs/Miss/Ms/Other:

Initials: Surname:

Address:

.....

..... Post Code:

Telephone:

Date of installation/...../.....

Room Installed (e.g. Kitchen):

Your details will only be held by Smiths Environmental Products Ltd and used solely to provide customer services and product information.
 If you do not wish to be contacted, please put an x in the box.