

Caspian[®] CTFF

EC variants with Smart Controls



Installation, commissioning
and user manual



CT60FF | CT120FF
EC Series Fan Convectors

Contents

Introduction	2
Declaration of conformity	3
Symbols used in this guide	3
Important safety and installation instructions	4
Product dimensions	6
Product performance	7
Control mounting options	8
Wiring diagrams	8
Installation	10
Installation - Remote smart controller	11
Commissioning	12
User guide for Wi-Fi thermostat	13
Getting started - programming your thermostat	14
Maintenance	18
Fault finding	18
Accessories	19
Registering your product	19
Disposal	19
After sales and spares	19

Introduction

These heaters must not be installed in wet rooms or other high humidity areas.

These heaters are designed for use on standard two-pipe pumped central heating systems with a maximum water temperature of 86°C and a maximum pressure of 6 bar (88lbs/in.).

Pipe connections are 22mm, in order to obtain maximum efficiency and output the flow should be connected to the header tube which is nearest the exiting air side of the heat exchanger.

When mounting the zone valve to the system pipework the arrows indicating flow direction must be observed and respected.

These heaters are classified as a fixed appliance and the electrical connection should be via a 3A fused spur. The fused spur must not be directly below the heater but should be accessible after completion of the installation. All heaters must be earthed.

To avoid the possibility of vibration these units must be fitted to a flat even surface.

Please note that the guarantee may be invalidated if this product is not installed and used in accordance with these instructions.

Note: 15mm pipe may be used for heating capacities of up to 12kW. (This is subject to compliance with CIBSE recommendations)

Declaration of conformity

EC Declaration of conformity

We, Smith's Environmental Products Limited
1-2 Blackall Industrial Estate
South Woodham Ferrers
Chelmsford
Essex CM3 5UW
Tel: 01245 324900 Fax: 01245 324422

Declare under sole responsibility that the products:

Product name:
Caspian

Product range:
**Caspian Smart Control Range - Caspian UV,
Caspian FF, Caspian EXT, Caspian SL, Caspian
TT, Caspian UVC sizes 60, 90, 120, 150 & 180**

Conform to the following European
Union directives:

**Low Voltage Directive 2014/35/EU
Safety of household electrical appliances:
EN 60335-2-80:2003, +A1:04 +A2:09
EN 60335-1:2012 +A11:14 +A13:17 +A14:19
+A1:19 +A2:19**

**Electromagnetic compatibility (EMC)
EN 55014-1:2017
ETSI EN300 328: V2.1.1:2016
EN55014-2:2015**

This Declaration is made on behalf of Smith's
Environmental Products Limited.

Salus controller

The Salus controller independently complies with
the essential requirements and other relevant
provisions of Directives 2014/30/EU, 2014/35/EU,
2014/53/ EU and 2011/65/EU. The full text of the
EU Declaration of Conformity is available at the
following internet address: www.saluslegal.com.

Symbols

This manual contains information and
prescriptions marked by the following symbols.



Ignoring these safety provisions
marked by the symbol "caution:
hazard" may endanger the safety of
people.



Ignoring these safety provisions
marked by the symbol "caution:
electricity" may endanger the
safety of people, as well as the
integrity of things.



The removal of the screws can
cause the output of hot fluids
under high pressure from heating
system. Drain the system or close
the isolating valves.



High temperature surface. Take
utmost care to prevent people
from getting in contact with the
hot surfaces of the appliance.

Important safety and installation instructions

Prior to installation, read these installation and operating instructions. The installation and operation should also be in accordance with national regulations and accepted codes of good practice.



This appliance can be used by children aged from 8 years and above and persons with reduced physical, sensory or mental capabilities or lack of experience and knowledge if they have been given supervision or instruction concerning use of the appliance in a safe way and understand the hazards involved. Children shall not play with the appliance. Cleaning and user maintenance shall not be made by children without supervision.

To guard against injury, basic safety precautions should be observed, including the following:

1. Read and follow all safety instructions and all the important notices on the appliance before installing, using and maintaining the appliance. Failure to do so may cause personal injury or damage to the appliance or installation.
2. Always disconnect electrical supply before putting on or taking off parts and whilst the equipment is being installed, maintained or handled. Never work with bare feet and/or with wet hands.
3. A risk assessment should always be carried out prior to work, Correct PPE should be worn.
4. To avoid possible electric shock, special care should be taken since water is used with electrical equipment. Carefully examine the appliance before and after installation. Do not operate the appliance if it has a damaged supply cord or enclosure, or if it is malfunctioning or it is dropped or damaged in any manner. Inspect the appliance in accordance with manufacturers instructions.



The appliance should not be electrically supplied if there is water on parts not intended to be wet.

5. Risk of scalding. To avoid injury before any servicing operation wait until the water has cooled inside the appliance. Do not touch the fluid or the appliance when temperature is higher than 60°C.
6. Improper use.
This is an appliance to be used in heating systems with clean water without abrasive particles.



Do not use this appliance:

- With liquids other than water (e.g. flammable liquids, etc.) (EN60335-2-51);
- In locations where special conditions prevail, such as the presence of a corrosive or explosive atmosphere (dust, vapour or gas) (EN60335-2-51);
- For other than intended use.

7. Installation.

The appliance must be mounted in a stable/fixed position in a dry, well ventilated, frost-free, waterproof and protected place, with sufficient ventilation around it. Make sure that the appliance is securely and correctly installed before operating it and that there is enough room around it for maintenance operations, dismantling, checking for free inspection.

The maximum ambient temperature at which the appliance is to be used is 40°C (EN60335-2-51).



8. Electrical connection

Important: Connection to the power supply must be effected by means of a fixed power cable via a two pole isolating switch (fused spur) with a minimum contact opening of 3mm.

The fused spur must not be directly below the heater but should be accessible after completion of the installation. All heaters must be earthed.

Electrical connection must be carried out by a qualified electrician and in accordance with local regulations and both data on the name-plate and the appropriate diagram inside the terminal box cover.

Follow all safety standards.

9. All electrical work should be carried out in accordance with current IEEE regulations; we recommend the appliance is protected by a Residual Current Device (RCD or Ground-Fault Circuit-Interrupter) with a rated residual operating current not exceeding 30mA.
10. Prior to any modification being made to the equipment, it must be agreed with and authorised by the manufacturer. Original spare parts and accessories authorised by the manufacturer are integral part contributing to the safety of the equipment and of the appliance. The use of non original components or accessories may endanger the safety and causes the termination of the warranty. Safe operation is only assured for the applications and conditions described in Application of this manual.

Non-observance of the safety instructions results in the loss of any claims to damages.

The indicated limit values are binding and cannot be exceeded for any reason whatsoever.

KEEP THESE INSTRUCTIONS FOR FUTURE REFERENCE.

Product dimensions

Caspian CTFF

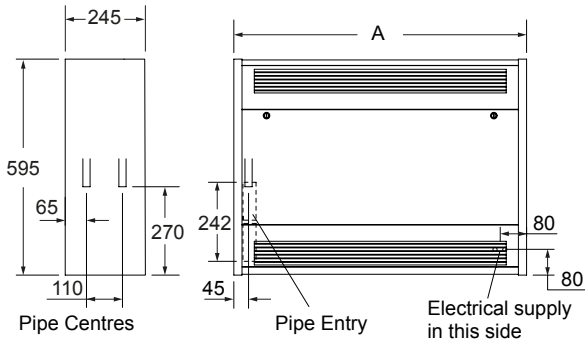

Model	A
60	595
120	1195

Installation Cutaway – T-Bar Ceiling

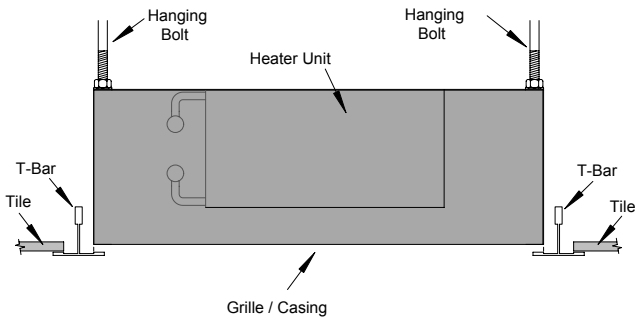

Product performance

Heat output - EC

Model Reference	Fan Speed	Control Voltage VDC	40°C MWT	45°C MWT	50°C MWT	55°C MWT	60°C MWT	65°C MWT	70°C MWT	75°C MWT	80°C MWT
EC 60	Low	3.4	0.85	1.20	1.45	1.80	2.16	2.35	2.73	3.08	3.40
	Mid	4.9	1.02	1.53	1.92	2.37	2.76	3.18	3.58	4.05	4.38
	High	6.4	1.18	1.85	2.38	2.93	3.36	4.00	4.43	5.02	5.36
EC 120	Low	3.1	1.62	2.34	3.32	3.98	4.71	5.62	6.32	6.99	7.61
	Mid	4.3	2.31	3.25	4.27	5.15	6.07	7.02	7.91	8.74	9.60
	High	5.5	2.99	4.15	5.21	6.31	7.42	8.41	9.50	10.48	11.59

Model Reference	Fan Speed	Air Volume (m³/h)	Air Volume (l/s)	Specific Fan Power w/l/s	Power Consumption (W)	NR in typical room*
EC 60	Low	201.00	55.90	0.14	8.00	34.00
	Mid	290.50	80.75	0.26	21.00	41.50
	High	380.00	105.60	0.32	34.00	49.50
EC 120	Low	419.30	116.50	0.14	16.00	34.00
	Mid	549.65	152.68	0.26	40.00	42.00
	High	680.00	188.89	0.34	64.00	49.96

*a typical room is taken as a room with a volume of 173m³ and a reverberation time of 0.8 seconds at 500 Hz with one unit installed, situated against a wall or ceiling (radiating noise in a quartersphere). No allowance is made for attenuation provided by ceilings, enclosures or ductwork. Outputs based upon testing at EN442: 2014 using mean water temperature and an entering air temperature of 20°C with a 10°C temperature drop between flow and return.

Model Reference	Fan Speed	Hydraulic Resistance (KPA)	Nominal Weight (KG)	Water Capacity (L)
EC 60	Low	1.38	23.00	0.92
	Mid	1.69		
	High	2.00		
EC 120	Low	17.78	45.00	2.08
	Mid	20.59		
	High	23.40		

Correction factors

Mean Water Temp °C		45 - 80			
Water Temperature drop °C		5	10	15	20
Entering Air Temperature °C	15	1.13	1.10	1.07	1.05
	18	1.08	1.05	1.02	0.99
	20	1.04	1.00	0.95	0.89
	25	0.93	0.91	0.89	0.86

Factors are approximate data based upon a standard coil.

How to calculate Mean Water Temperature (ΔT)

$$\text{Mean water temperature } (\Delta T) = \left(\frac{\text{Flow temperature} + \text{Return temperature}}{2} \right) - \text{Ambient Temperature}$$

Control mounting options/configurations

Internally mounted - To be specified at time of order (built to order) (tamper proof)

Wall mounted - Standard product (remote)

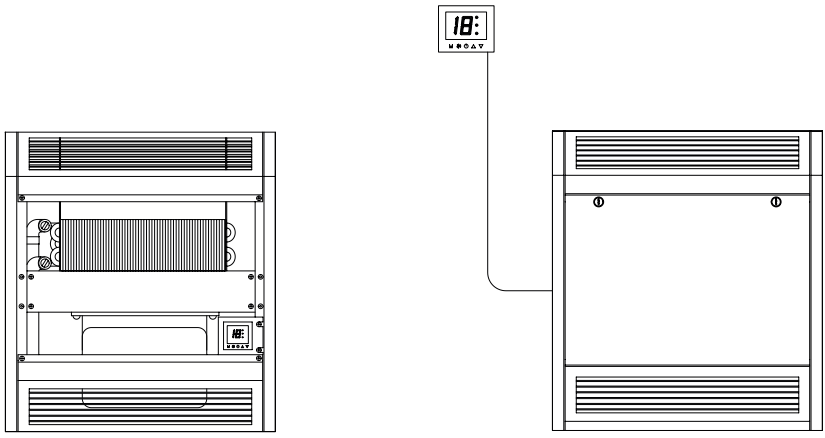

Wiring diagram - Master Slave

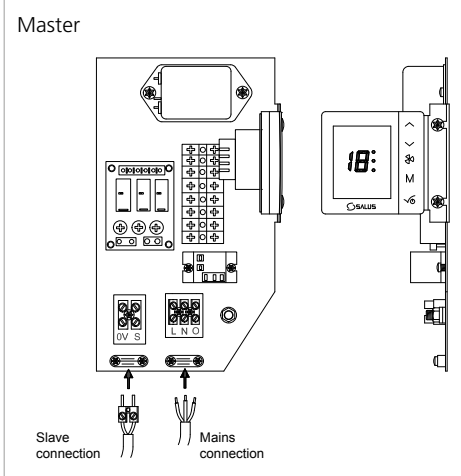

Internal control option (control adjacent to wiring panel)

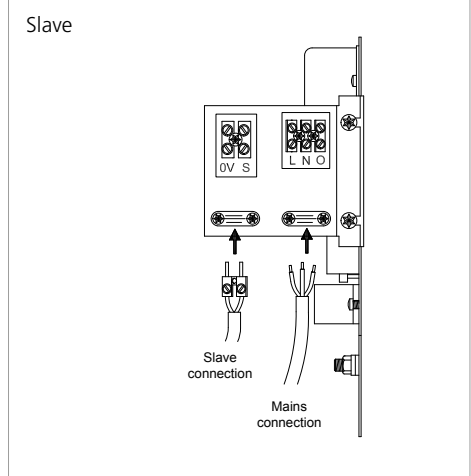

Remote / flush control options (electrical connection moved adjacent to wiring panel)

Wiring diagram - Standard

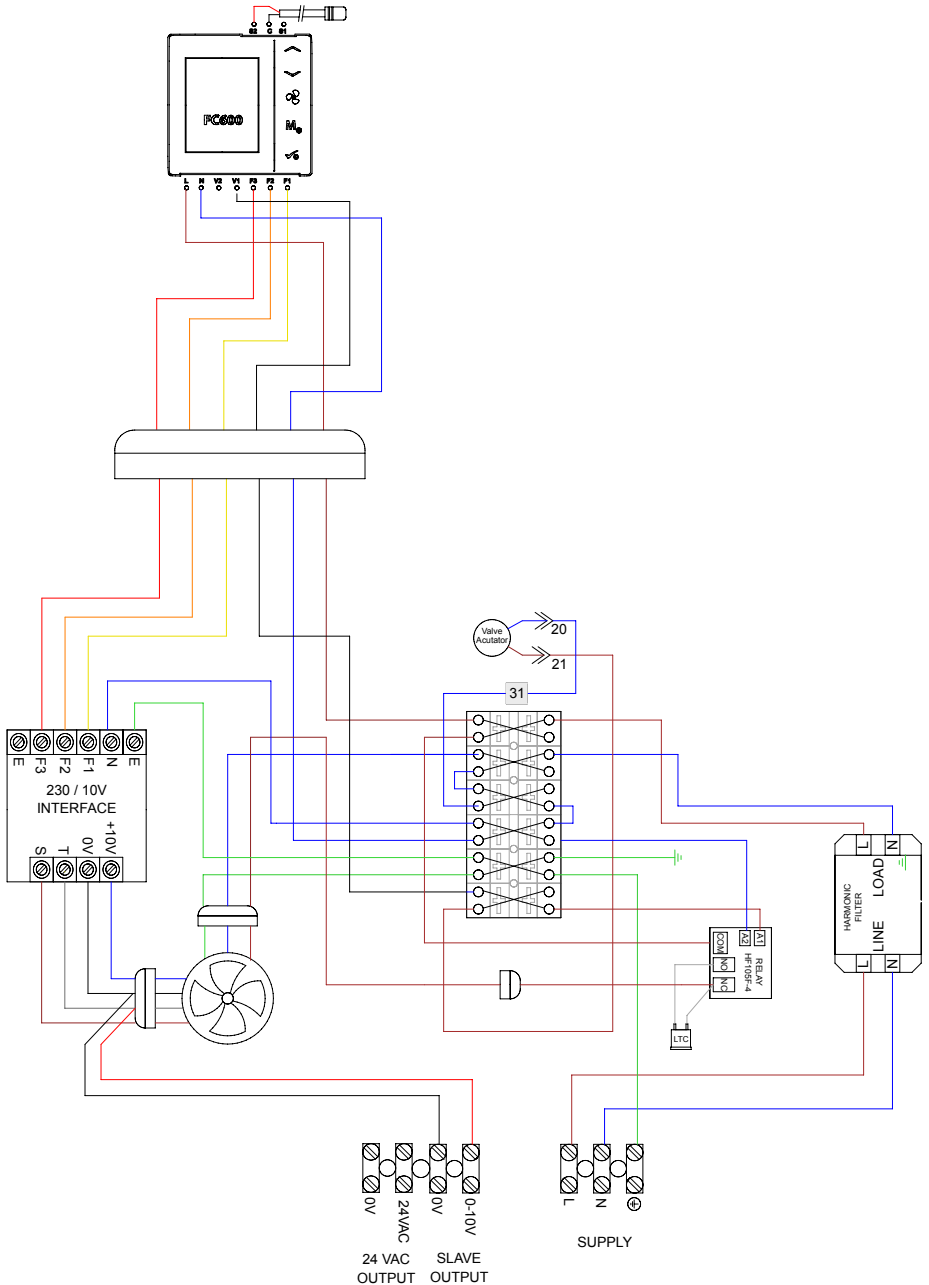

Where factory modification made separate diagram to be supplied

Installation

1. Unlock the front access panel

Unlock and lower the front access panel using the keys supplied. The keys come cable tied to the back of the heater.

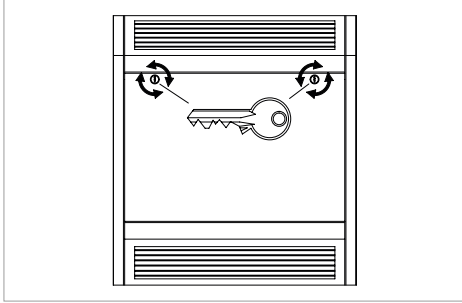

2. Fix unit to wall or ceiling

Fix the unit to the ceiling or wall via suitable fixings. If fitted to suspended ceilings or similar then suitable means of support such as threaded rods or chains must be used.

3. Connect the pipes

Connect the heating system flow and return pipes to the heater pipe work. Pipe entry/exit can be made through either the back of the unit or by using the pipe knockouts on the bottom of the unit. Do not use soldered fittings to connect the heater pipe work as the heat generated may cause damage to internal wiring and components. Compression fittings should be used. Pipework must only enter in intended cut outs or knockouts on the header connection side of the heater.

Note: 15mm pipework suitable for heating outputs up to 12kW, 22mm should be used where output exceeds 12kW (this is subject to compliance with CIBSE recommendations).

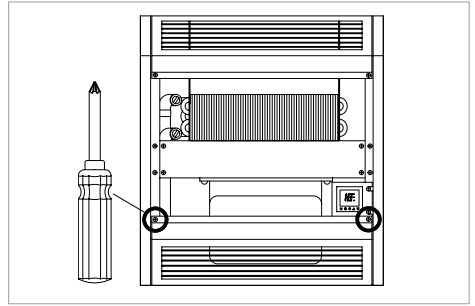

Note: The system must be flushed prior to fitting this heater. Failure to comply with this may effect the warranty.

Isolating valves must be fitted. We recommend the use of full-flow service valves. The valves should be accessible after completion of the installation. We also advise the fitting of an air vent at the highest point on either the flow or return pipe to remove any air trapped within the system. Valves must have the ability to regulate flow for balancing.

4. Open the service valves

Having filled the heating system with water, open the full flow service valves and check for water leaks. Remove any trapped air from the unit via the built in bleed screws as shown in the diagram below.

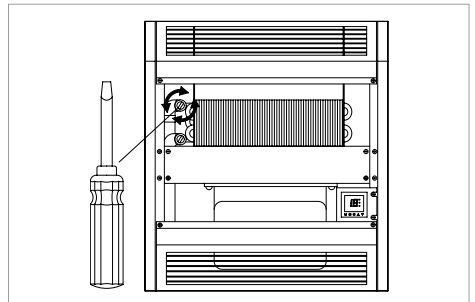

5. Electrical supply and electrical connection

Electrical supply to the unit must be nominal 230VAC 50~Hz.

Electrical connection to the product is via a 3 way terminal block inside the product (L, N, E), on electrical panel.

Connect the power supply from the fused spur (3 Amp) to the heater terminal block marked Supply E N L via the cable entry hole in the top chassis of the heater.

The fused spur must not be directly below the heater and must be accessible after the installation is complete.

All electrical work should be carried out in accordance with current IEEE regulations.

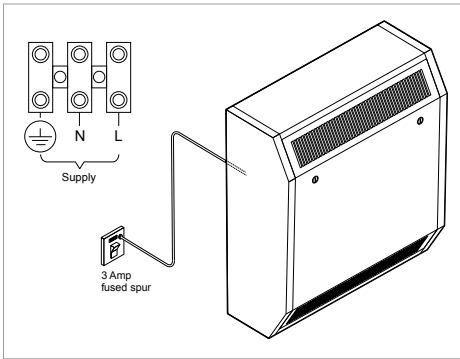

Installation - Remote smart controller

For Smart flush and integral control models continue to page 16.

1. Ensure power supply is switched off
2. Remove the mounting plate from the controller by inserting a small screwdriver into slots at base of controller. See Fig 2.
3. Fix the mounting plate to the wall using either a recessed or surface mounted back box using the screws provided. See Fig 3.
4. Connect power supply, connect wires into the appropriate terminals on the controller. See Fig 4.

5. Fasten body of thermostat and the mounting plate. See Fig 5.
6. When using external pattress box assemble as shown. See Fig 6.

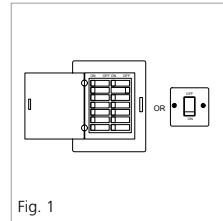
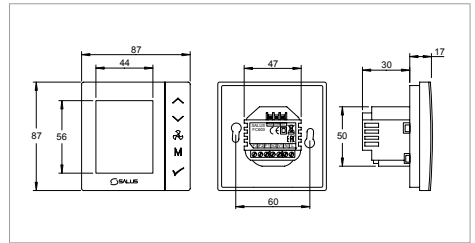

Fig. 1

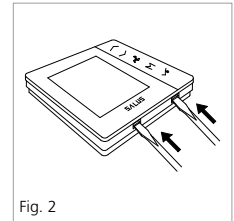

Fig. 2

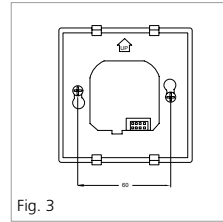

Fig. 3

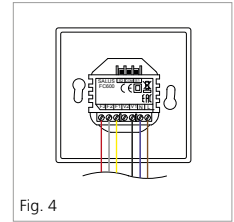

Fig. 4

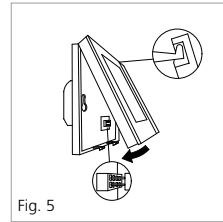

Fig. 5

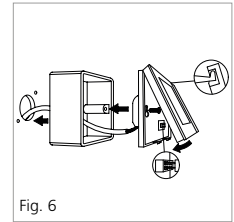
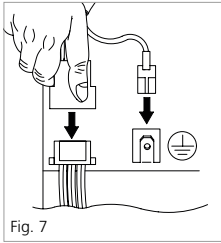

Fig. 6

Connecting remote smart controller to the heater

1. Feed the connector end of the wire harness through the cut outs in the back or underside of the unit.
2. Plug in the wire harness connector block to the female connector block situated on the heater electrical; panel as shown in Fig 7.
3. Connect the earth connector to the earth tag on the wiring panel adjacent to the connector block as shown in Fig 7.



Remote sensor wiring

Remote sensor may be used where the thermostat will remain internally to the unit. See wiring diagram S2 and C connections.

Master/slave wiring, hard wire

A number of units may be controlled from one thermostat. For connection details please see wiring diagram on page 9.

Note:

Maximum units: 4
Maximum total distance (Cable): 40 metres

Commissioning

1. Turn on the electrical supply at the fused spur.
2. Set the thermostat to maximum using the increase button on the controller.
3. Turn on the central heating system.
4. Balance the central heating system to ensure the correct system flow rate is achieved.
5. If the installation is working correctly remember to reset the thermostat control to its normal setting.
6. Set the fan speed control to the desired setting (low, medium or high) using the fan speed button on the controller.
7. Internal mounted (tamper proof) models only. Close the front access panel, ensure this is secure and locked in place with the keys provided.
8. This Installation and User Guide must be left with the user for future reference.



Heating operation

Ensure the central heating system is ON. Switch on the power supply to the unit. Set the thermostat control to the desired temperature.

Providing the water temperature in the central heating system is more than 38°C (Standard LTC only) and the thermostat is calling for heat the product will switch on.

Quick user guide for Wi-Fi Thermostat



A SALUS FC600 is a device suitable for controlling your Caspian unit in 2 pipe systems and for managing the temperature in your home and/or working environment. For an internet connection (Online Mode), this product must be used with the SALUS Universal Gateway Hub (UG600/UGE600) - available as an accessory product code: HACA33130 and SALUS Smart Home App



You can also use the SALUS FC600 without an internet connection (offline mode). Go to <https://salus-controls.com/uk/product/fc600/#downloads> for the full PDF version of the manual.

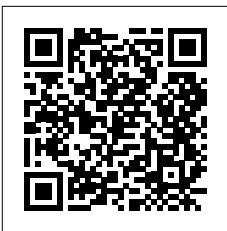

Button functions

Key	Function			
	Increase Button			
	Decrease Button			
	Fan Speed Low, Medium, High, Auto, Off			
	Mode Button	Digital	Short press	Long press (2sec)
		Program-mable	Heat/Cool/Eco selection	Offset, Time
		Permanent override AUTO	Heat/Cool/Eco selection	Programmable schedule Offset Time&Date
	Short press: Confirm function			
	Long press (2 sec): Activate/deactivate standby mode			

Complete setup instructions for the control can be found at:

<https://salus-controls.com/uk/product/fc600/#downloads>

LCD Icon descriptions

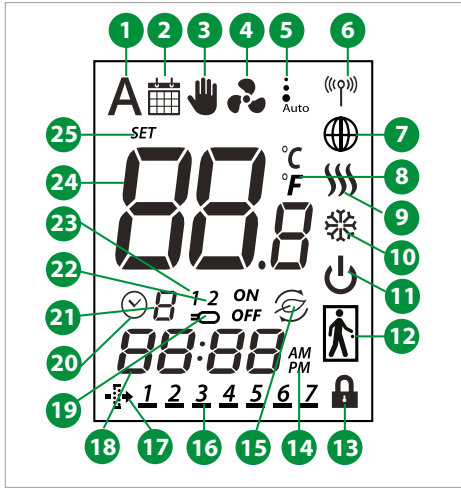

1. Auto heat/cool selection
2. Schedule icon
3. Permanent/temporary override
4. Fan is running (icon is animated)
5. Fan speed (low, medium, high, Auto, OFF)
6. Wireless communication with the Universal Gateway
7. FC600 is connected to the Universal Gateway and Internet
8. Temperature unit
9. Heating Mode ON
10. Cooling Mode ON
11. Standby mode
12. Occupancy/vacancy sensor
13. Lock function
14. AM/PM
15. Eco Mode
16. Current day of the program
17. Filter needs to be replaced
18. Current time
19. Sensor indicators
20. Timer icon
21. Program number
22. Sensor indicators
23. Sensor indicators
24. Room/setpoint temperature
25. Setpoint temperature indicator



Getting started

All units are factory configured in off-line stand alone mode and tested for function when built.

Should your unit require setup from storage or reconfiguration to "Smart Home" App control follow the steps below to ensure successful setup and operation.

1. Setup as stand alone control
(Confirm unit function)
2. Connect to "Smart Home" App
Requires Universal Gateway Hub (UG600)
available as an accessory product code:
HACA33130

Note: These instructions demonstrate settings and setup required to work with our appliance. Complete setup instructions for the control can be found at:

<https://salus-controls.com/uk/product/fc600/#downloads>

or use the QR code below:

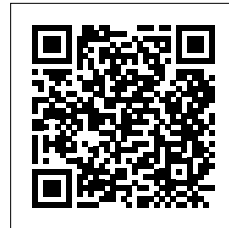

- When powered for the first time the control will boot (Software version will appear) after a sort time the display will change to show "U9 - Yes"
- This should be "U9 - No" by pressing the up arrow, followed by the tick/confirm button. See image 1 and 2.

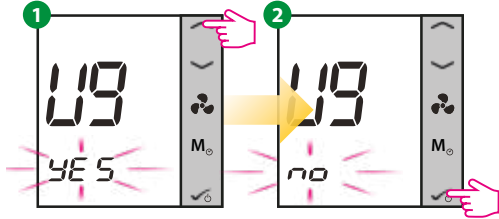

- The next screen display "USE - 2 Pipe" Change this to "4 Pipe" and confirm parameters (Note: 4 Pipe setting is required to allow fan only function). See images 3 and 4.

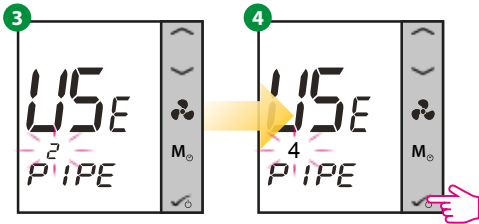

- Set the S1 and S2 parameters as shown:
S1 - noFN (No Function)
S2 - S2sens (External Temperature Sensor)

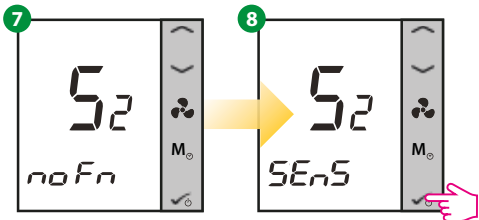
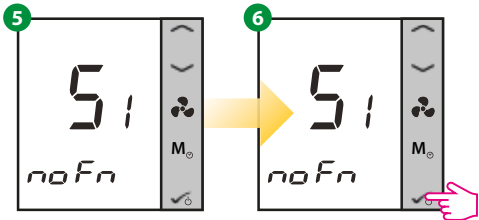

- Select the thermostat mode, although this unit is heating only by setting heating and cooling allows the use of fan only/ventilation if required. See images 9 and 10.

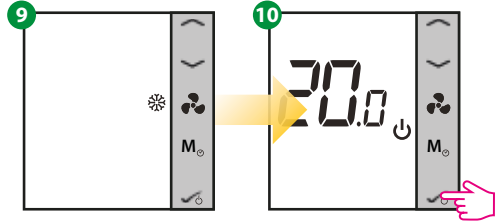

Press UP/DOWN to select the operating mode to .

Press to confirm.

You are now in Standby Mode.

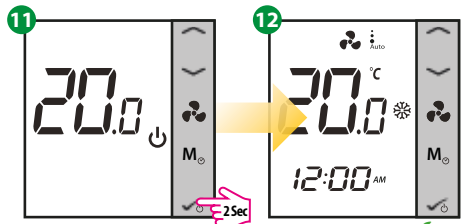

Press and hold for 2 seconds

Success! Installation completed.

Changing from offline mode to online mode

If you want to use the internet App and the Universal Gateway Hub UG600 (available as an accessory product code: HACA33130), you need to change your thermostat settings from offline mode to online mode. For that please follow the steps below:

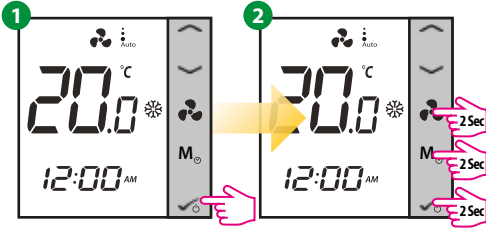

Press OK once then press and hold 3 buttons for 2 seconds.

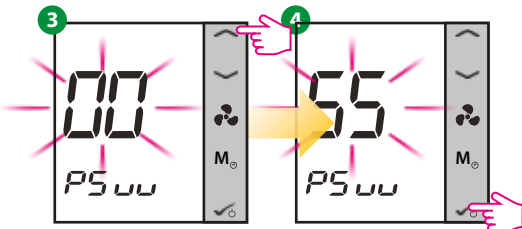

The digits on the screen will flash. Using the up/down keys enter pass 55 then click OK.

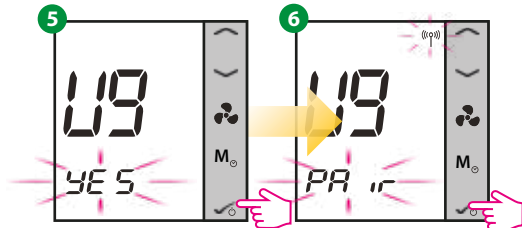

Press Ok and then short press button to confirm pairing.

Press **Scan for equipment** from the App and follow the on screen instructions.

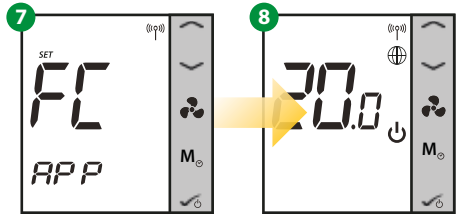

Set up your device on the App.

You're now in Standby Mode.

Note: To view detail of set up, operation and parameters, please consult the full manual at: <https://salus-controls.com/uk/product/fc600/#downloads>

Temporary override

To temporarily override and cause the heater to function follow steps 1-5. This should be used during the commissioning process.

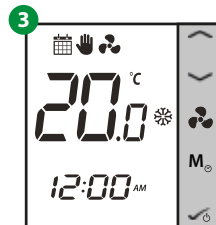
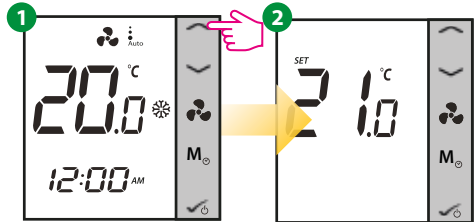

Note: The temporary override will be active until the next program starts. You can cancel the temporary Override by pressing **M**

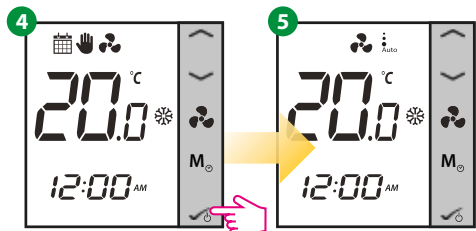

Factory reset

If you have made an error or need to change your system parameters, or want to return to the factory settings, please follow steps below. By performing this action you will lose all your settings. Factory reset will only take effect on the thermostat you are working on.

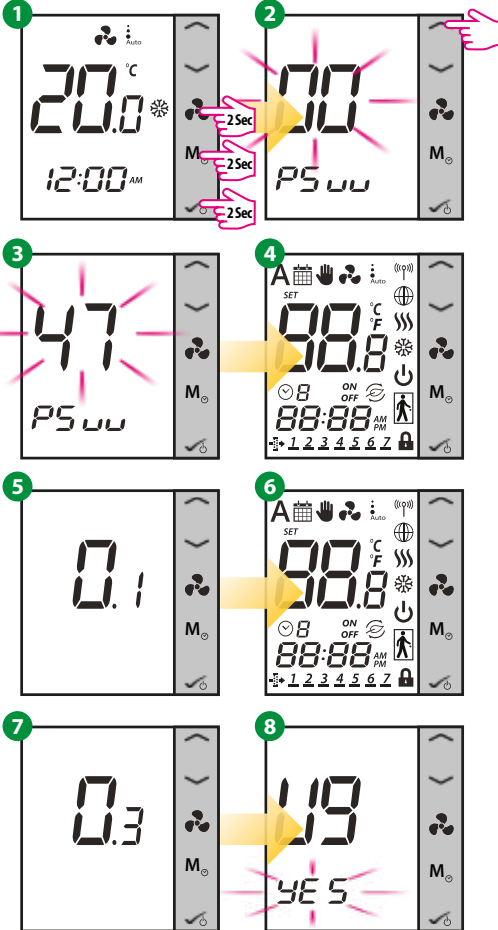

User Guide

For further information and to view detail of set up, operation and parameters, please consult the full manual at:

<https://salus-controls.com/uk/product/fc600/#downloads>

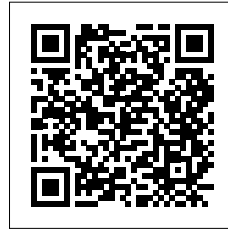

SALUS Smart Home App



You can also access the web version at:

<http://eu.salusconnect.io/>

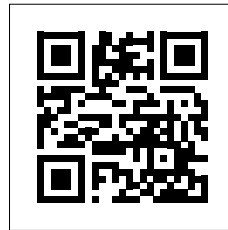

Youtube

<https://www.youtube.com/user/SalusControls>

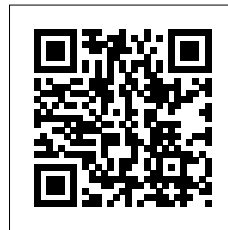

Maintenance

Warning! Isolate from the electrical supply before performing any work on the unit.

The internal air filter is removable for servicing. To gain access to the filter unlock and lower the front access panel, remove the 2 screws from the filter enclosure panel and lift out. Carefully lift out and remove filter. The filter should be gently tapped to remove any accumulated dust and vacuumed if necessary (approx. every 6 months). We recommend replacing the filters approx. every 2 years depending on environmental conditions.

The coil fins are delicate so take care and only use a soft brush or vacuum cleaner to remove any dust that may have accumulated.

The fan(s) and motors should not require servicing. Please contact your supplier if damaged.

To replace filter use reverse the removal instructions and ensure the lower front access panel is securely locked.

Please note in the event of an engineer's visit, Smith's Environmental Products Ltd reserve the rights to apply a call-out charge should the fault prove to be with the system or installation and not the heater appliance.

Fault finding

Providing the power supply is switched on and the thermostat control is calling for heat the heater will switch on and off automatically with the central heating system.

In the event of any difficulty, please contact us on +44 (0) 1245 324560.

It will be helpful if you do not disconnect the heater from the central heating system.

Fault	Checking/Solution
The fan does not run on any speed setting	Check the power supply is switched ON Check the fuse in the fused spur Check the wiring at the fused spur Check the controller is switched on and calling for heat Check the central heating is switched ON Vent any trapped air from the system (with the heating system turned OFF)
No heat output	Check flow and return pipes are hot Vent any trapped air from the system (with the heating system turned OFF) Check the controller is switched on and calling for heat If a thermostat is fitted ensure it is calling for heat Balance the central heating system if installed on the same circuit as panel radiators and increase the circulating pump speed if required Increase the boiler water temperature

Accessories

Air inlet filters for all models

Universal Gateway Hub UG600 for use with internet App control

For accessories or spares please refer to our price list, contact your supplier or Smith's Environmental Products Ltd.

Registering your product

Thank you for purchasing a Smith's product. It has been designed and manufactured to the highest quality standards to ensure it gives you efficient and trouble-free service for many years. We are committed to achieving the highest standards and our faith is supported by a free parts and labour guarantee with every product.

For more information on the warranty period for this product please visit our website smithsep.co.uk/product-registration/

This gives you the peace of mind that in the unlikely event of product failure, we will repair or replace the product completely free of charge providing the product has been installed, used and maintained in accordance with the instructions. Your statutory rights are not affected by this warranty.

It is important to register as soon as possible online at: smithsep.co.uk/product-registration/. This will ensure you will receive prompt and efficient service if your product requires attention within the warranty period. If you do not register your product, you will be required to produce proof of purchase prior to receiving service.

For more details please visit our website: SmithsEP.co.uk

SCAN HERE TO REGISTER
YOUR PRODUCT



Disposal

As part of the policy of continuous product improvement, Smith's Environmental Products LTD reserves the right to alter specification without prior notice.

Products with this symbol (crossed out wheellie bin) cannot be disposed as household waste. Old electrical and electronic equipment must be recycled at a facility capable of handling these products and their waste by-products. If you are purchasing replacement equipment your retailer may offer a 'take back' scheme, or will be able to give details of the nearest approved authorised treatment facility. Proper recycling and waste disposal will help conserve resources whilst preventing detrimental effects on our health and the environment.

WEEE Registered Code: WEE/ED0093VW



Approved CQS ISO
9001:2015



ISO 14001

After sales and spares

If you experience any problems with the use of your product, please contact our after-sales office +44 (0) 1245 324560.

For product information, customer services or sales support call us on +44 (0) 1245 324900

For the Republic of Ireland, contact MT Agencies on 01 864 3363

Sales: sales@SmithsEP.co.uk

General information: info@SmithsEP.co.uk

Smith's Environmental Products Ltd
Blackall Industrial Estate, South Woodham Ferrers,
Chelmsford, Essex CM3 5UW

SmithsEP.co.uk

@SmithsEP_UK

#ThinkSmiths



Happy to help

Smith's Environmental Products Ltd is one of the leading manufacturers of heating and cooling products in the UK. We are committed to achieving the highest standards and our faith is supported by a free parts and labour guarantee with every product (see our website for more information). Our customer service is second to none and we are happy to offer any help and guidance that you might need.

Stockists

All products are available nationally from Builders' Merchants, Plumbers' Merchants, Heating Equipment Distributors and Kitchen Equipment Distributors. In the event of difficulty, please contact us or visit our website SmithsEP.co.uk for details of your nearest stockist.

Information and advice

Full technical specifications and list prices is available to download from our website or in hard copy from our office. Also available on our website are price lists, individual product data sheets, installation & user guides, where to buy, who to contact and a media centre.

Alternatively contact our office 9.00am to 5.00pm Monday to Friday.

As part our commitment to continuous improvement Smith's Environmental Products may change the specifications of its products without prior notification or public announcement. All descriptions, illustrations, drawings and specifications in this publication present only general particulars and shall not form part of any contract. All dimensions are in mm unless otherwise stated. Please visit the website for the most up to date information.

**To view the full product information
download the datasheet at:
www.SmithsEP.co.uk**

For product information, customer services or sales support call us on **+44 (0) 1245 324900**

For the Republic of Ireland, contact MT Agencies on 01 864 3363

Sales: sales@SmithsEP.co.uk

General information: info@SmithsEP.co.uk

Smith's Environmental Products Ltd
Blackall Industrial Estate, South Woodham Ferrers,
Chelmsford, Essex CM3 5UW

SmithsEP.co.uk

[@SmithsEP_UK](https://twitter.com/SmithsEP_UK)

[#ThinkSmiths](https://www.facebook.com/ThinkSmiths)

Issue 001 | 85-0061 | October 2023