

# Space Saver

Installation, commissioning  
and user manual

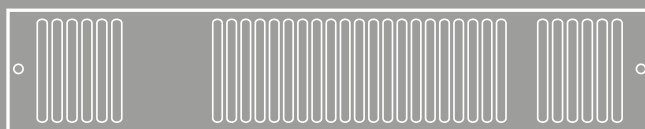

SS2E | SS3E | SS80E

# Contents

Introduction	2
Declaration of conformity	2
Symbols used in this guide	3
Important safety and installation instructions	3/4
Application	4
Product Information	5
<hr/>	
Installation - Heater	6
Installation - Controller	7
Pairing - Controller with Heaters	8
Commissioning	10
Fault finding	12
<hr/>	
User Manual	
Important safety guidance	14
Introduction	15
Operation	16
Fault finding	22
<hr/>	
Installation and user manual - Controller	23
<hr/>	
Registering your product	33
Disposal	33
After sales and spares	33

# Introduction

The following items are included in the carton:

- Product complete with grille and pre-wired mains cable
- Fixing screws (2)
- Wireless controller

Accessory grilles are available in different colours and finishes. Please consult the price list for details. In the event of any items missing or visible damage, please contact us on +44 (0) 1245 324560.

Please leave this Installation and User Manual with the owner of the property.

# Declaration of conformity

EC Declaration of conformity

We, Smith's Environmental Products Limited  
1-2 Blackall Industrial Estate  
South Woodham Ferrers  
Chelmsford  
Essex CM3 5UW  
Tel: 01245 324900 Fax: 01245 324422

Declare under sole responsibility that the products:

Product name:  
**Space Saver**

Product range:  
**SS2E, SS3E, SS80E**

Listed above confirms with the following European Union directives:

**Low Voltage Directive (73/23/EEC)**

**EMC Directive (89/336/EEC)**

**Pressure Equipment Directive (97/23/EC)**  
**Machinery (98/37/EC)**

Standards comply with the above directives.

Safety Directive Standards:

**EN 60335-2-80:2003 + A1:04 in conjunction  
with EN 60335-1:2002 + A11:04 + A1:04 +  
A12:06 + A2:06  
With UK deviations**

This Declaration is made on behalf of Smith's Environmental Products Limited.

# Symbols

This manual contains information and prescriptions marked by the following symbols:



Ignoring these safety provisions marked by the symbol "caution: hazard" may endanger the safety of people.



Ignoring these safety provisions marked by the symbol "caution: electricity" may endanger the safety of people, as well as the integrity of the equipment.



High temperature surface. Take utmost care to prevent people from getting in contact with the hot surfaces of the appliance.

## Important safety and installation instructions

Prior to installation, read these installation and operating instructions. The installation and operation should also be in accordance with national regulations and accepted codes of good practice.



This appliance is not intended for use by persons (including children) with reduced physical, sensory or mental capabilities, or lack of experience and knowledge, unless they have been given supervision or instruction concerning use of the appliance by a person responsible for their safety. Children should be supervised to ensure that they do not play with the appliance.

To guard against injury, basic safety precautions should be observed, including the following:

1. Read and follow all safety instructions and all the important notices on the appliance before installing, using and maintaining the appliance. Failure to do so may cause personal injury or damage to the appliance or installation.
2. Always disconnect electrical supply before putting on or taking off parts and whilst the equipment is being installed, maintained or handled. Never work with bare feet and/or with wet hands.
3. Carefully examine the appliance before and after installation.  
Do not operate the appliance if it has a damaged supply cord or enclosure, or if it is malfunctioning or it is dropped or damaged in any manner. Inspect the appliance periodically.



4. Improper use.

Do not use this appliance:

- In locations where special conditions prevail, such as the presence of a corrosive or explosive atmosphere (dust, vapour or gas) (EN60335-2-51);
- For other than intended use.



5. Installation.

The appliance must be mounted in a stable/fixed position in a dry, well ventilated, frost-free, waterproof and protected place, with sufficient ventilation around it. Make sure that the appliance is securely and correctly installed before operating it and that there is enough room around it for maintenance operations, dismantling, checking for free inspection.

The maximum ambient temperature at which the appliance is to be used is 40°C (EN60335-2-51).

# Important safety and installation instructions

Prior to installation, read these installation and operating instructions. The installation and operation should also be in accordance with national regulations and accepted codes of good practice.



## 6. Electrical connection

**IMPORTANT:** Connection to the power supply must be effected by means of a fixed power cable which is fitted with a plug-type connection or a two pole isolating switch with a minimum contact opening of 3 mm.

Electrical connection must be carried out by a qualified electrician and in accordance with local regulations and both data on the name-plate and the appropriate diagram inside the terminal box cover.

Follow all safety standards.

## 7. Connect the appliance only to a mains supply protected by a Residual Current Device (RCD or Ground-Fault Circuit-Interrupter) with a rated residual operating current not exceeding 30mA.

## 8. Prior to any modification being made to the equipment, it must be agreed with and authorised by the manufacturer. Original spare parts and accessories authorised by the manufacturer are integral part contributing to the safety of the equipment and of the machines. The use of non original components or accessories may endanger the safety and causes the termination of the warranty. Safe operation is only assured for the applications and conditions described in Application of this manual.

Non-observance of the safety instructions results in the loss of any claims to damages.

The indicated limit values are binding and cannot be exceeded for any reason whatsoever.

KEEP THESE INSTRUCTIONS FOR FUTURE REFERENCE.

## Application

Space Saver is primarily intended for installation in the space beneath kitchen cupboards behind the plinth. However, it can be also installed in similar applications such as stair cases and other built-in furniture.

This Space Saver model must NOT be installed in a bathroom or other areas of high humidity. Please contact us on +44 (0) 1245 324560 for details of products suitable for these applications.

In compliance with LOT20 European legislation, this product is supplied with a wireless battery powered wall-mounted time and temperature controller. This heater will NOT function without the wall-mounted controller. The controller can control an unlimited number of heaters.

Space Saver is fitted with an overheat protection. The heater will automatically stop in the event of the heating elements reaching the cut-out temperature.

Please note the guarantee may be invalidated if this product is not installed and used in accordance with this guide.

# Product dimensions and performance

## SS2E

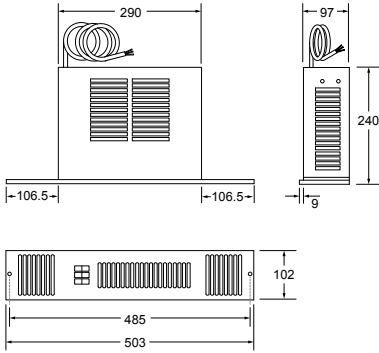

### Heat output

Heat Output (kW)	Power Consumption (kW)	Fused spur	Mains Cable (m)
1kW/2kW	1kW/2kW	10A	2.0

Voltage: 230V

## SS80E

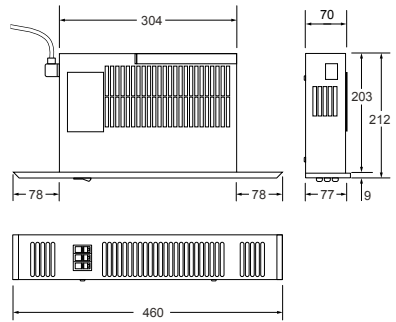

### Heat output

Heat Output (kW)	Power Consumption (kW)	Fused spur	Mains Cable (m)
0.6kW/1.2kW	0.6kW/1.2kW	10A	2.0

## SS3E

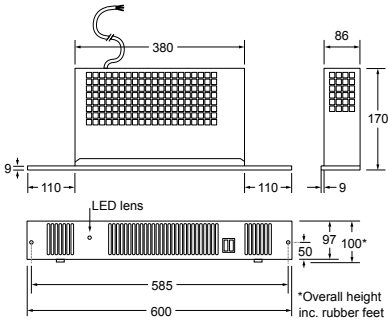

### Heat output

Heat Output (kW)	Power Consumption (kW)	Fused spur	Mains Cable (m)
1kW/2kW/3kW	1kW/2kW/3kW	13A	2.0

## WALL CONTROLLER

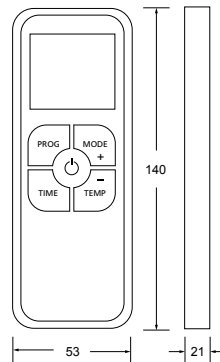

# Installation - Heater

## 1. Cut the opening in the plinth

- To ensure adequate airflow, a minimum clearance of 20mm (10mm for SS80E product) between the top of the product and any shelving is essential
- To avoid the possibility of vibration, this product must be installed on a flat, even surface
- There must be no rear access to the product after completion of the installation

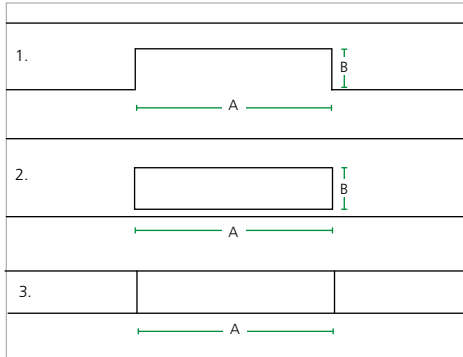

- We recommend the use of a knee pad when installing this product
- Cut the opening in the plinth to the size shown in the table. Use method 1 or 2. 3 represents installation into a 80mm plinth (SS80E only)

Model	Width A (mm)	Height B* (mm)
SS2E	465	97
SS3E	570	95
SS80E	400	74

\* The overall height of the grille is 100mm. Use care when cutting the opening.

## 2. Electrical connection - Heater

- Isolate the electrical supply and connect the heater electric cable to the fused spur
- The fused spur must not be directly above the heater, but should be accessible after completion of the installation

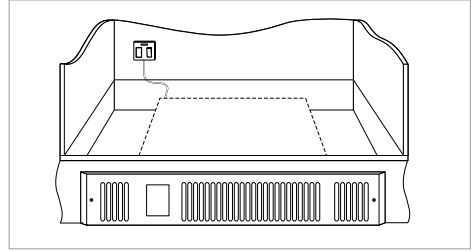

Electrical installation should be carried out by a competent installer, preferably registered with NICEIC (National Inspection Council for Electrical Installation Contracting) in accordance with the 17 edition of the IEE Wiring Regulations, (BS.7671), and any relevant Local Authority Bye-Laws. This heater is fitted with a 3-core mains supply cable and should be permanently connected to the electricity supply via a double pole switch having 3mm gap on each pole. A switched Fused Connection unit to BS.1363. Part 4 is a recommended mains supply connection accessory to ensure compliance with safety requirements applicable to fixed-wiring installation.

## 3. Position heater

- Position the heater, making sure the electrical cable is not snagged

## 4. Fix to plinth

- Fix heater to plinth

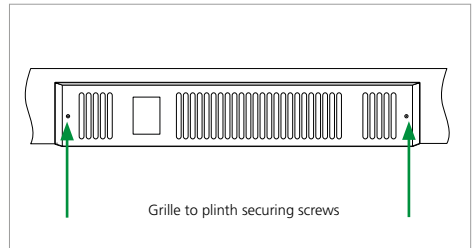

## 5. Overlay grille (optional)

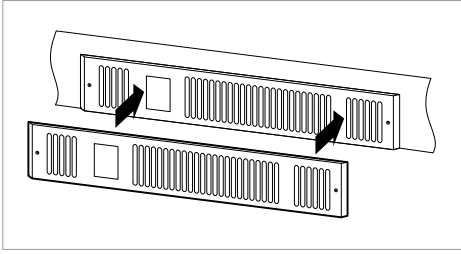

- If required fit the overlay grille
- Remove the screws holding the fixed grille to the plinth
- Place the overlay grille over the fixed grille and refit the screws

## Installation - Controller Introduction

In compliance with LOT20 European legislation, this product is supplied with a wireless battery powered wall-mounted time and temperature controller. The product will NOT function without the wall-mounted controller. The controller can control an unlimited number of heaters.

The controller is primarily designed to minimise energy wastage and ensure the room is maintained at the comfort level set by the user. In the basic setting, the controller is a simple room thermostat in which the heater will run until the set temperature is reached. If the room temperatures falls the heater will switch on again until the set temperature is reached. The operating range is between 15°C and 35°C.

The controller also has a number of advanced features that, if required MUST be set during the installation process. Please discuss with your customer which features they require.

- **Programmable Timer**  
To allocate designated time slots in which the room will be heated.
- **Frost Protection**  
Can be used in situations where you require a minimum room temperature to be maintained, between 4-15 degrees C.

- **Maximum Temperature Setting**  
This can be set to limit the maximum temperature set by the user.
- **Open Window Detect**  
Will switch off the heating to limit the loss of energy when it detects a sudden temperature drop as a result of an open window or door, switching back on when it detects it has been closed again.

## 1. Choosing a position in a room for the wall controller

The Controller should be positioned 1.5m above the floor and in the same room/space as the heater.

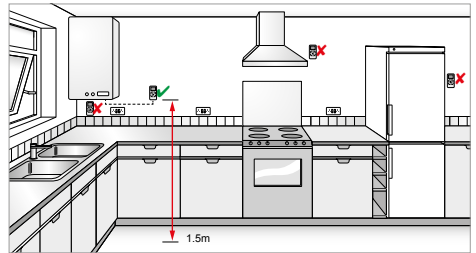

The controller should be fixed to the wall. Avoid areas with draught or direct sun. Do not position the controller above or close to the heaters or other heat sources. Damp areas or areas where the controller can be mechanically damaged should also be avoided. Avoid installing the controller in areas where there are metal objects between the heater and the controller. This will reduce the RF range. The RF range in ideal conditions can be up to 20m however this can be reduced when the signal is passing through the walls or other objects. The range can be also affected where the controller is mounted close to power cables, motors or equipment producing strong electromagnetic field. If the temperature control feature is used it is necessary to use one controller for each room or zone.

## 2. Installation - Basic Setting

The controller is supplied with a white plastic mounting bracket that needs to be fixed to a wall at 1.5m above floor level. Install the two AA batteries, supplied, into the Controller. The batteries should be replaced every 12 months.

# HHPS01 Wireless Controller – Quick Set Up

1. Ensure the heater is installed and connected to the mains power supply.  
**DO NOT TURN THE MAINS POWER ON AT THE WALL UNTIL ASKED IN THE INSTRUCTIONS BELOW.**



2. Unpackage the controller and install the batteries. Use a small Phillips screwdriver to release the controller from the bracket. The screen should now show the current room temperature.



3. Set the heater fan switch to **ON**. Switch on the power at the wall and **within 20 seconds** simultaneously press and hold the **PROG** and **MODE** buttons on the controller until the screen shows **PAIR**.

The controller will revert to showing room temperature and the heater unit will run. With water-based heating systems, if the central heating system is not turned on and the water temperature is cool then the unit will switch off after four seconds. Electric heaters will continue to run if the demand temperature is higher than the ambient room temperature.



*Note: Failure to switch on the power and initiate pairing within 20 seconds will result in the heater and controller not being paired and the heater unit should be switched off at the wall and the pairing process should be restarted from Step 3.*

4. The controller can be set into one of four modes – **BOOST, MANUAL, FROST PROTECT** and **AUTO**. To cycle through the four modes press the **MODE** button so the screen backlight illuminates, then repeatedly press the **MODE** button until the required mode is shown on the screen.



If the **MODE** button is not pressed quickly enough then the controller will drop into the last mode that was selected as you were pressing the button and the next time you opt to change modes it will start again at the beginning of the list. Full details of each mode can be found in the controller manual.





5. To set the required thermostat temperature press the **TEMP** button to bring up the adjustment icon on the screen. Use the + and – buttons to select the required temperature. The radiator symbol will appear when heating is demanded.
6. On electric fan heaters, set the heat output switches on the front of the heater to the desired position.

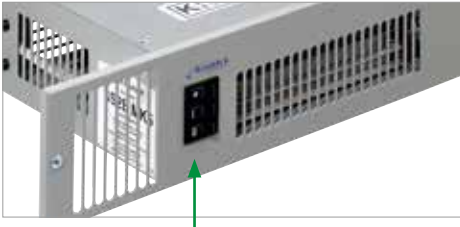

7. To turn off the heating, press the **POWER** button in the centre of the controller (DO NOT HOLD THE BUTTON IN) to go into **STANDBY**. Pressing the power button again will switch the heating back on into the last mode that was selected, and with the last room temperature that was set.

Advanced setup options are described fully in the Controller User Manual at the end of this document (page 23).

# Commissioning

## SS2E

1. Before switching the heater on, please ensure the fascia grille is free from obstruction
2. Ensure your fused spur is switched ON
3. Ensure the heater is paired with the wireless controller
4. Ensure the controller is switched on and calling for heat
5. Set the upper fan switch and the middle 1kW switch to ON
6. If you require a faster warm up, set the lower 2kW switch to ON. Please note all switches must be in the ON position to achieve 2kW output
7. To turn the heater OFF, set the controller switch to OFF (heating symbol not shown on display)

For your safety this Space Saver heater is fitted with an automatic overheat protection. If the heater stops, turn off the power at the fused spur, wait 5 minutes and switch the power back on.

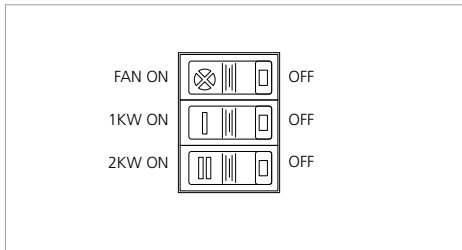

## SS3E

1. Before switching the heater on, please ensure the fascia grille is free from obstruction
2. Ensure your fused spur is switched ON
3. Ensure the heater is paired with the wireless controller
4. Ensure the controller is switched on and calling for heat
5. A. For 1kW heat output set the left hand switch to 1kW ON  
B. For 2kW heat output set the right hand switch to 2kW ON  
C. For 3kW heat output set both switches to ON
6. To turn the heater OFF set the controller switch to OFF (heating symbol not shown on display)

Space Saver is fitted with an electronic safety (ES) control which is a safety device which switches off the heater, if for any reason, the appliance overheats. The ES controls can only be reset after the appliance has cooled down in order to reset the ES control see fault finding.

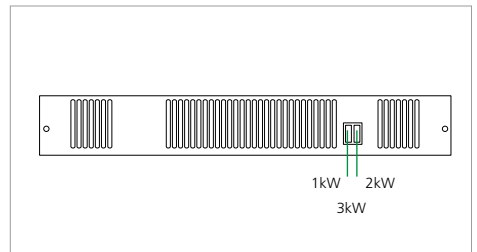

## SS80E

1. Before switching the heater on, please ensure the fascia grille is free from obstruction
2. Ensure your fused spur is switched ON
3. Ensure the heater is paired with the wireless controller
4. Ensure the controller is switched on and calling for heat
5. Set the upper fan switch and the middle switch 600W to the ON position
6. If you require a higher heat setting then set the bottom 1200W switch to the ON position
7. To turn the heater OFF set the controller switch to OFF (heating symbol not shown on display)

For your safety this Space Saver heater is fitted with an automatic overheat protection. If the heater stops, turn off the power at the fused spur, wait 5 minutes and switch the power back on.

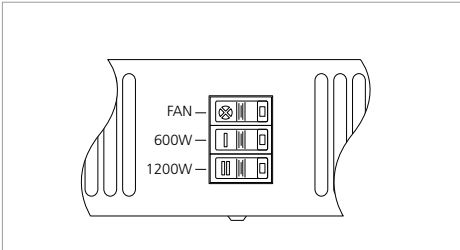

# Commissioning - see page 10

## Fault finding

In the event of any difficulty, please contact us on +44 (0) 1245 324560.

Fault	Checking/Solution
Fan does not run/no heat output	Check the power supply is switched ON Check fuse in fused spur Check the fan switch is set to ON Check the battery in the controller and replace if necessary Check the wireless controller thermostat is calling for heat Check the thermostat and controller is paired to the heater
If the overheat protection has activated, manual reset as follows:	1. Switch the power supply OFF at the fused spur 2. Wait 5 minutes for the overheat cut-out switch to reset 3. Switch the power supply on

### Wireless Controller Self Diagnostic

The controller is equipped with a self diagnostic software that will check functionality of all main components. If there is a fault with any part of the controller or controller is operating outside of the temperature limits, the display will show 'Err' on the display. If this happens, controller will not function in order to protect itself and the heaters.

# Space Saver

User manual

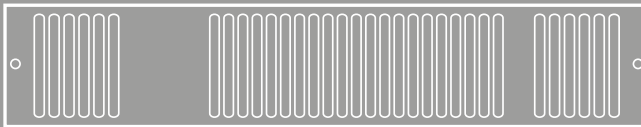

SS2E | SS3E | SS80E

# Important safety and installation instructions

Please read this user manual before operating this appliance. The operation should also be in accordance with national regulations and accepted codes of good practice.



This appliance is not intended for use by persons (including children) with reduced physical, sensory or mental capabilities, or lack of experience and knowledge, unless they have been given supervision or instruction concerning use of the appliance by a person responsible for their safety. Children should be supervised to ensure that they do not play with the appliance.

To guard against injury, basic safety precautions should be observed, including the following:

1. Read and follow all safety instructions and all the important notices on the appliance before installing, using and maintaining the appliance. Failure to do so may cause personal injury or damage to the appliance or installation.
2. Always disconnect electrical supply before putting on or taking off parts and whilst the equipment is being installed, maintained or handled. Never work with bare feet and/or with wet hands.
3. Carefully examine the appliance before and after installation.  
Do not operate the appliance if it has a damaged supply cord or enclosure, or if it is malfunctioning or it is dropped or damaged in any manner. Inspect the appliance periodically.



4. Improper use.

Do not use this appliance:

- In locations where special conditions prevail, such as the presence of a corrosive or explosive atmosphere (dust, vapour or gas) (EN60335-2-51);
  - For other than intended use.
5. Installation.

The appliance must be mounted in a stable/fixed position in a dry, well ventilated, frost-free, waterproof and protected place, with sufficient ventilation around it. Make sure that the appliance is securely and correctly installed before operating it and that there is enough room around it for maintenance operations, dismantling, checking for free inspection.

The fascia grille must be free from obstruction.

The maximum ambient temperature at which the appliance is to be used is 40°C (EN60335-2-51).



## Warnings (Controller)

- Do NOT handle the appliance with wet hands.
- Do NOT use the appliance in workshops or rooms where excessive dust is generated or present.
- Ensure that nothing is pushed into any aperture of this controller.
- Do NOT cover or restrict any aperture
- Do NOT use the appliance if damaged.
- Do NOT use in a bathroom
- Operating temperature range -10 to +40°C.

# How it works - Heater

Cooler air is drawn in by the fan and heated as it passes through the heating element before being discharged gently back into the room. This not only gives a more even temperature spread, but will heat up a room quicker than a traditional panel radiator.

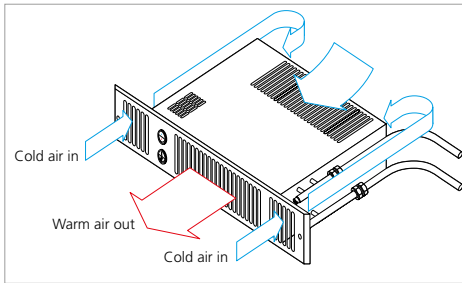

# Introduction

In compliance with LOT20 European legislation, this product is supplied with a wireless battery powered wall-mounted time and temperature controller. The product will NOT function without the wall-mounted controller. The controller can control an unlimited number of heaters.

The controller is primarily designed to minimise energy wastage and ensure the room is maintained at the comfort level set by the user. In the basic setting, the controller is a simple room thermostat in which the heater will run until the set temperature is reached. If the room temperatures falls the heater will switch on again until the set temperature is reached. The operating range is between 15°C and 35°C.

The controller has a number of advanced features that, if required MUST be set during the installation process. Please discuss with your customer which features they require.

- **Programmable Timer**  
To allocate designated time slots in which the room will be heated.
- **Frost Protection**  
Can be used in situations where you require a minimum room temperature to be maintained, between 4-15 degrees C.
- **Maximum Temperature Setting**  
This can be set to limit the maximum temperature set by the user.

- **Open Window Detect**  
Will switch off the heating to limit the loss of energy when it detects a sudden temperature drop as a result of an open window or door, switching back on when it detects it has been closed again.

## Wall Controller



## Batteries in Wall Controller

It is recommended that the batteries are changed every 12 months to protect potential damage by batteries leaking (batteries are supplied with the controller)

You do not need to re-pair after batteries have been changed (pairing is done by programming the chip memory)

# How to operate

## SS2E

### Manual Mode

1. Ensure your fused spur is switched ON
2. Ensure the wireless controller is ON, and paired
3. Switch the upper fan switch to ON
4. Use the MODE button to select Manual Mode
5. Set the thermostat to the desired temperature
6. Set the middle 1kW switch to ON
7. If you require a faster warm up, also set the lower 2kW switch to ON

Please note all switches must be in the ON position to achieve 2kW output

8. To turn the heater OFF, press the power button in the centre of the Controller.

For your safety this Kitchen Heater is fitted with an automatic overheat protection. If the heater stops, turn off the power at the fused spur, wait 5 minutes and switch the power back on.

#### Air Circulation (Summer use)

Set the thermostat to maximum set the fan switch to ON ensure the 1kW and 2kW switches are set to OFF. Kitchen Heater will provide a cooling flow of air.

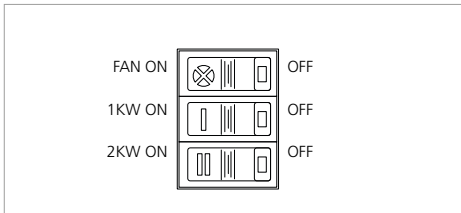

### Boost Mode

1. Ensure your fused spur is switched ON
2. Ensure the wireless controller is ON, and paired
3. Switch the upper fan switch to ON
4. Use the MODE button to select Boost Mode
5. Adjust the temperature as required (default 35 degrees). Boost will run for 15 minutes. Press PROG to increase the boost period, up to 4 hours.
6. Set the middle 1kW switch to ON
7. If you require a faster warm up, also set the lower 2kW switch to ON

Please note all switches must be in the ON position to achieve 2kW output

8. Press MODE button again to cancel Boost Mode at any time.
9. To turn the heater OFF, press the power button in the centre of the Controller.

For your safety this Kitchen Heater is fitted with an automatic overheat protection. If the heater stops, turn off the power at the fused spur, wait 5 minutes and switch the power back on.

#### Air Circulation (Summer use)

Press MODE and select Boost Mode, set the fan switch set the fan switch to ON ensure the 1kW and 2kW switches are set to OFF. Kitchen heater will provide a cooling flow of air for as long as the boost period lasts

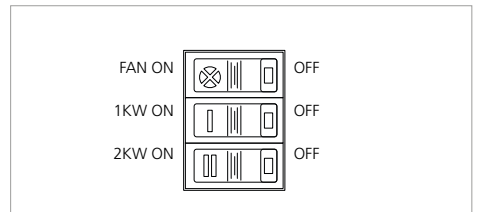



## Frost Protect Mode

1. Ensure your fused spur is switched ON
2. Ensure the wireless controller is ON, and paired
3. Switch the upper fan switch to ON
4. Use the MODE button to select Frost Protect Mode
5. Adjust the temperature to set the minimum temperature required (4-15 degrees). The Controller needs to remain turned ON, and in Frost Protect mode, in order to work.
6. Set the middle 1kW switch to ON
7. If you require a faster warm up, also set the lower 2kW switch to ON

Please note all switches must be in the ON position to achieve 2kW output

8. The heater will maintain the desired minimum temperature as the ambient temperature falls
9. To turn the heater OFF, press the power button in the centre of the Controller

For your safety this Kitchen Heater is fitted with an automatic overheat protection. If the heater stops, turn off the power at the fused spur, wait 5 minutes and switch the power back on.

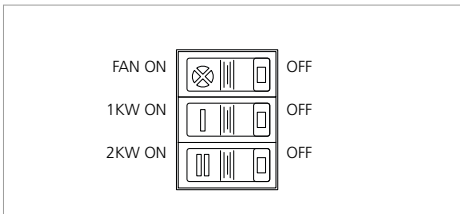

## Auto Mode

1. Ensure your fused spur is switched ON
2. Ensure the wireless controller is ON, and paired
3. Switch the upper fan switch to ON
4. Use the MODE button to select Auto Mode
5. Ensure the correct Time is set and programme the desired schedule as per the full instruction manual
6. Set the middle 1kW switch to ON
7. If you require a faster warm up, also set the lower 2kW switch to ON

Please note all switches must be in the ON position to achieve 2kW output

8. To advance ahead in the schedule, press the PROG button. To cancel and revert back to the programme schedule, press PROG again
9. The temperature can be adjusted during the programme, as normal, but will revert back to the programmed temperatures at the next changeover point
10. To turn the heater OFF, press the power button in the centre of the Controller.

For your safety this Kitchen Heater is fitted with an automatic overheat protection. If the heater stops, turn off the power at the fused spur, wait 5 minutes and switch the power back on.

### Air Circulation (Summer use)

Set the thermostat to maximum set the fan switch to ON ensure the 1kW and 2kW switches are set to OFF. Kitchen Heater will provide a cooling flow of air.

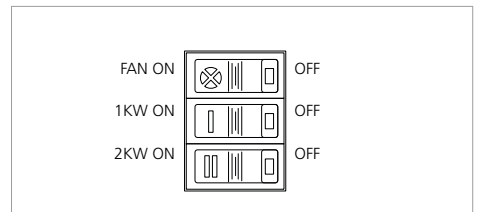

# How to operate

## SS3E

### Manual Mode

1. Ensure your fused spur is switched ON
2. Ensure the wireless controller is ON, and paired
3. Use the MODE button to select Manual Mode
4. Ensure the wireless controller is switched on and calling for heat
5. Switches on the right hand side of fascia control heat output:
  - A. For 1kW heat output set the left hand switch to 1kW ON
  - B. For 2kW heat output set the right hand switch to 2kW ON
  - C. For 3kW heat output set both switches to ON
6. To turn the heater OFF, press the power button in the centre of the Controller

Space Saver is fitted with an electronic safety (ES) control which is a safety device which switches off the heater, if for any reason, the appliance overheats. The ES controls can only be reset after the appliance has cooled down in order to reset the ES control see fault finding.

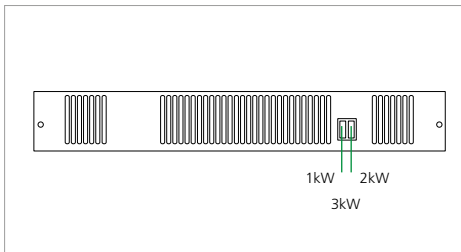

### Boost Mode

1. Ensure your fused spur is switched ON
2. Ensure the wireless controller is ON, and paired
3. Use the MODE button to select Boost Mode
4. Adjust the temperature as required (default 35 degrees). Boost will run for 15 minutes. Press PROG to increase the boost period, up to 4 hours.
  - A. For 1kW heat output set the left hand switch to 1kW ON
  - B. For 2kW heat output set the right hand switch to 2kW ON
  - C. For 3kW heat output set both switches to ON
5. Press MODE button again to cancel Boost Mode at any time.
6. To turn the heater OFF, press the power button in the centre of the Controller

For your safety this Kitchen Heater is fitted with an automatic overheat protection. If the heater stops, turn off the power at the fused spur, wait 5 minutes and switch the power back on.

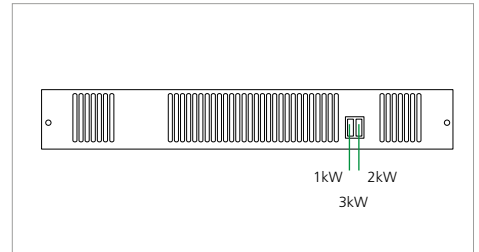

## Frost Protect Mode

1. Ensure your fused spur is switched ON.
2. Ensure the wireless controller is ON, and paired
3. Use the MODE button to select Frost Protect Mode
4. Adjust the temperature to set the minimum temperature required (4-15 degrees). The Controller needs to remain turned ON, and in Frost Protect mode, in order to work.
5. For 1kW heat output set the left hand switch to 1kW ON
  - A. If you require a faster warm up, for 2kW heat output set the right hand switch to 2kW ON
  - B. For 3kW heat output set both switches to ON
6. The heater will maintain the desired minimum temperature as the ambient temperature falls
7. To turn the heater OFF, press the power button in the centre of the Controller

For your safety this Kitchen Heater is fitted with an automatic overheat protection. If the heater stops, turn off the power at the fused spur, wait 5 minutes and switch the power back on.

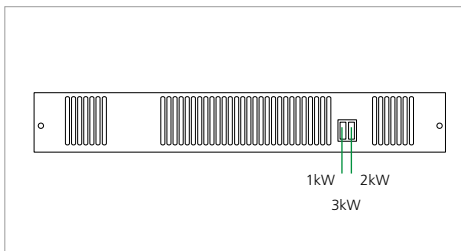

## Auto Mode

1. Ensure your fused spur is switched ON
2. Ensure the wireless controller is ON, and paired
3. Use the MODE button to select Auto Mode
4. Ensure the correct Time is set and programme the desired schedule as per the full instruction manual
5. For 1kW heat output set the left hand switch to 1kW ON
  - A. If you require a faster warm up, for 2kW heat output set the right hand switch to 2kW ON
  - B. For 3kW heat output set both switches to ON
6. To advance ahead in the schedule, press the PROG button. To cancel and revert back to the programme schedule, press PROG again
7. The temperature can be adjusted during the programme, as normal, but will revert back to the programmed temperatures at the next changeover point
8. To turn the heater OFF, press the power button in the centre of the Controller

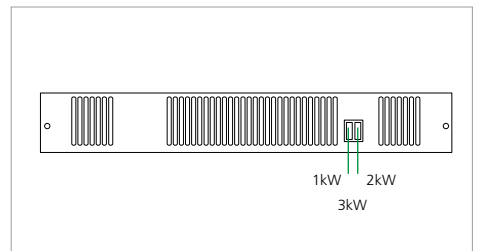

# How to operate

## SS80E

### Manual Mode

1. Ensure your fused spur is switched ON
2. Ensure the wireless controller is ON, and paired
3. Use the MODE button to select Manual Mode
4. Set the thermostat to the desired temperature
5. Switch the upper fan switch to ON
6. Set the middle switch 600W to ON
7. If you require a faster warm up, also set the lower 1200W switch to ON

Please note all switches must be in the ON position to achieve 1200W output

8. To turn the heater OFF, press the power button in the centre of the Controller

For your safety this Kitchen Heater is fitted with an automatic overheat protection. If the heater stops, turn off the power at the fused spur, wait 5 minutes and switch the power back on.

#### Air Circulation (Summer use)

Set the thermostat to maximum set the fan switch to ON ensure the 600W and 1200W switches are set to OFF. Space Saver will provide a cooling flow of air.

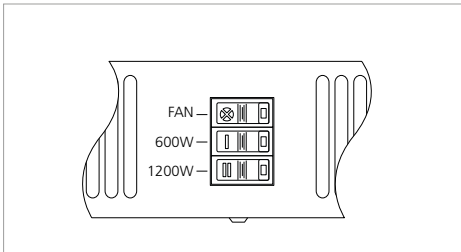

### Boost Mode

1. Ensure your fused spur is switched ON
2. Ensure the wireless controller is ON, and paired
3. Switch the upper fan switch to ON
4. Use the MODE button to select Boost Mode
5. Adjust the temperature as required (default 35 degrees). Boost will run for 15 minutes. Press PROG to increase the boost period, up to 4 hours.
6. Set the middle 600W switch to ON
7. If you require a faster warm up, also set the lower 1200W switch to ON

Please note all switches must be in the ON position to achieve 1200W output

8. Press MODE button again to cancel Boost Mode at any time.
9. To turn the heater OFF, press the power button in the centre of the Controller

For your safety this Kitchen Heater is fitted with an automatic overheat protection. If the heater stops, turn off the power at the fused spur, wait 5 minutes and switch the power back on.

#### Air Circulation (Summer use)

Press MODE and select Boost Mode, set the fan switch to ON ensure the 600W and 1200W switches are set to OFF. Kitchen heater will provide a cooling flow of air for as long as the boost period lasts.

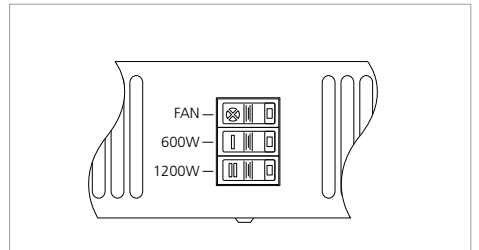

## Frost Protect Mode

1. Ensure your fused spur is switched ON
2. Ensure the wireless controller is ON, and paired
3. Switch the upper fan switch to ON
4. Use the MODE button to select Frost Protect Mode
5. Adjust the temperature to set the minimum temperature required (4-15 degrees). The Controller needs to remain turned ON, and in Frost Protect mode, in order to work.
6. Set the middle 600W switch to ON
7. If you require a faster warm up, also set the lower 1200W switch to ON

Please note all switches must be in the ON position to achieve 1200W output

8. The heater will maintain the desired minimum temperature as the ambient temperature falls
9. To turn the heater OFF, press the power button in the centre of the Controller.

For your safety this Kitchen Heater is fitted with an automatic overheat protection. If the heater stops, turn off the power at the fused spur, wait 5 minutes and switch the power back on.

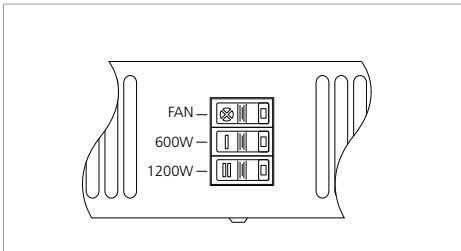

## Auto Mode

1. Ensure your fused spur is switched ON
2. Ensure the wireless controller is ON, and paired
3. Switch the upper fan switch to ON
4. Use the MODE button to select Auto Mode
5. Ensure the correct Time is set and programme the desired schedule as per the full instruction manual
6. Set the middle 600W switch to ON
7. If you require a faster warm up, also set the lower 1200W switch to ON

Please note all switches must be in the ON position to achieve 1200W output

8. To advance ahead in the schedule, press the PROG button. To cancel and revert back to the programme schedule, press PROG again
9. The temperature can be adjusted during the programme, as normal, but will revert back to the programmed temperatures at the next changeover point
10. To turn the heater OFF, press the power button in the centre of the Controller

For your safety this Kitchen Heater is fitted with an automatic overheat protection. If the heater stops, turn off the power at the fused spur, wait 5 minutes and switch the power back on.

### Air Circulation (Summer use)

Set the thermostat to maximum set the fan switch to ON ensure the 600W and 1200W switches are set to OFF. Kitchen Heater will provide a cooling flow of air.

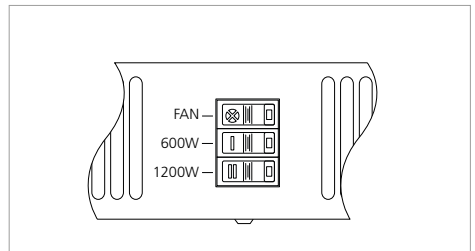

# Fault finding

This Space Saver is covered by a free 5-year parts and labour guarantee.

Please refer to the Fault finding table below for advice.

In the event of difficulty, please contact us on +44 (0) 1245 324560.

Fault	Checking/Solution
Fan does not run/no heat output	Check the power supply is switched ON Check fuse in fused spur Check the fan switch is set to ON Check the battery in the controller and replace if necessary Check the wireless controller thermostat is calling for heat Check the thermostat and controller is paired to the heater
If the overheat protection has activated, manual reset as follows:	<ol style="list-style-type: none"><li>1. Switch the power supply OFF at the fused spur</li><li>2. Wait 5 minutes for the overheat cut-out switch to reset</li><li>3. Switch the power supply on</li></ol>

## Wireless Controller Self Diagnostic

The controller is equipped with a self diagnostic software that will check functionality of all main components. If there is a fault with any part of the controller or controller is operating outside of the temperature limits, the display will show 'Err' on the display. If this happens, controller will not function in order to protect itself and the heaters.

# HHPS01 Controller

Installation and control  
user manual

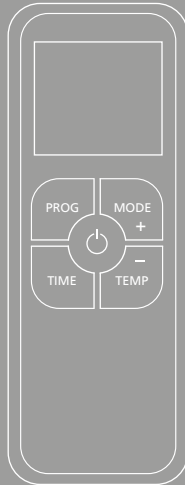

HHPS01  
WIRELESS CONTROLLER

# Contents

Introduction	24
Declaration of conformity	25
Product dimensions	25
Pairing the heater to the HHPS01	26
Basic Operation	26
Boost mode	27
Manual temperature mode	27
Frost protection mode	27
Auto mode	27
Heat Symbol	27
Keys locking	28
Open Window Detection	28
Displaying the time/temperature	28
Setting the automatic program schedule	29
Automatic program overview	30
Basic Overview	30
Set program inactive	30
Copy day function	30
Setup menu	31
Choosing a position in a room	32
Installing the controller	32
Batteries	32
Registering your product	33
Disposal	33
After sales and spares	33

# Introduction

In the event of items missing or visible damage please contact us on 01245 324560.

Keep the batteries out of reach of children

- Do NOT use if the battery compartment is not secure
- Dispose of used batteries correctly and safety
- Operating temperature range -10 to +40°C.

Please note the guarantee may be invalidated if this product is not installed and used in accordance with this guide.



# Declaration of conformity

In accordance with UK Government Guidance.

THE APPLIANCES DETAILED HEREON HAVE BEEN INSPECTED AND TESTED, AND CONFORM TO THE REQUIREMENTS OF THE FOLLOWING UK STATUTORY INSTRUMENTS WHERE APPLICABLE:

Electrical Equipment (Safety) Regulations 2016  
SI. 2016 1101

Electromagnetic Compatibility Regulations 2016  
SI. 2016 No. 1091

Radio Equipment Regulations 2017  
SI. 2017 No. 1206

The Ecodesign for Energy Related Products and Energy Information (Amendment) (EU Exit) Regulations 2019. SI. 2010 2617

The Restriction of use of Certain Hazardous Substances. SI. 2012 No. 3032

The Waste Electrical and Electronic Equipment Regulations 2013. SI. 2013 No. 3113

Transposed standards used:

BSEN55014 (2006)  
BSEN301 489.1 & .3  
BSEN300 220.1 & .2  
BSEN60730.2.9  
BSEN60335.1(2012)  
BSEN60335.2.30 (2009)

# Product dimensions

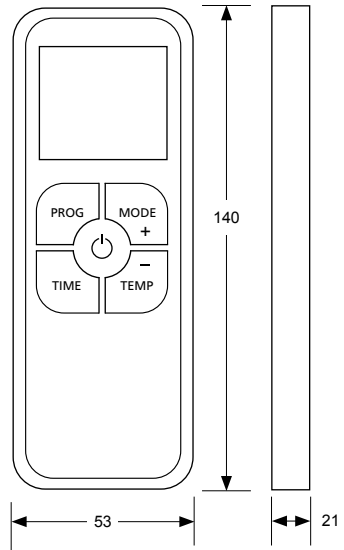

## Overview

The HHPS01 wireless controller can control an unlimited number of products provided they are within range. To do this, the controller must be paired with each heater. **The heater will not operate until it has been paired to the controller.**

## Pairing the heater to the HHPS01

In order to pair your appliance with the controller you must:

- Ensure power to the appliance is OFF.
- Set the heater fan switch to ON.
- Turn the power to the appliance ON.
- Within 20 seconds, press and hold the PROG and MODE buttons on the controller until the display shows 'PAIR'
- The fan should run and the appliance ready to be used.

## Basic operation

The HHPS01 also has a **STANDBY MODE**. To enter/exit this mode, press the standby button. In **STANDBY MODE**, the heating will not be activated and the display will be blank.

The HHPS01 has 4 standard operating modes: **BOOST, MANUAL, FROST PROTECT and AUTO**. Each mode can be selected by pressing the MODE button to cycle through the options. The cycle sequence will always start with **BOOST** mode followed by **MANUAL, FROST PROTECTION** and **AUTO**.

The HHPS01 also has two special operating modes. These are **MANUAL CONTROL MODE** and **LOCAL TEMPERATURE CONTROL MODE**. These are accessed via setup menu.

To adjust the operating mode/settings of the HHPS01, the display must first be activated. If the controller is in **STANDBY MODE**, press the power button. The controller will exit standby mode and the display will be activated for 10 seconds. If the controller is not in **STANDBY MODE**, press any of the TIME, TEMP or MODE buttons once. The display will be activated for 10 seconds.

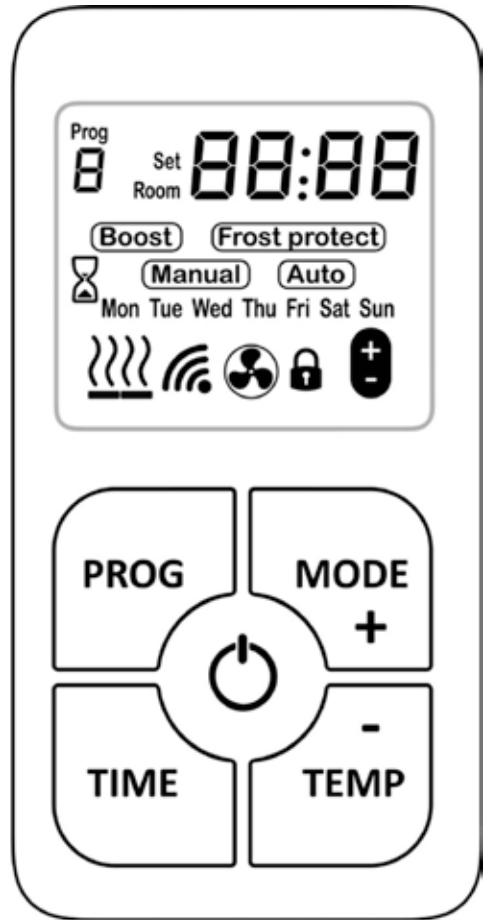

## Boost mode

The boost feature increases the room temperature for 15 minutes.

To amend the set temperature when in **BOOST** mode, activate the display and then press TEMP. Next, use the + and - buttons to change the temperature. Once the temperature is set, you can leave the display to return to the main screen and the settings will be saved. After 15 minutes, the HHPS01 will return to the previous operating mode.

Whilst in boost mode, activate the display and press the PROG button to increase the boost period. The boost period can be increased up to 4 hours. This will reset back to 15 minutes once you exit boost mode.



## Manual temperature mode

In **MANUAL** mode, the heater maintains a chosen set temperature between 15°C and 35°C. To amend the set temperature when in **MANUAL** mode, activate the display and then press TEMP. Next, use the + and - buttons to change the temperature. Once the temperature is set, you can leave the display to return to the main screen and the settings will be saved.

When the room temperature reaches the set temperature, the heating is disabled.

## Frost protection mode

In **FROST PROTECT** mode, the heater maintains a chosen set temperature between 4°C and 15°C. To amend the set temperature when in **FROST PROTECT** mode, activate the display and then press TEMP. Next, use the + and - buttons to change the temperature. Once the temperature is set, you can leave the display to return to the main screen and the settings will be saved.



## Auto mode

In this mode, the HHPS01 will follow the week's time / temperature program.

The temperature can be temporarily overridden in **AUTO** mode by simply activating the display and using the + and - buttons to set the new temperature. The new set temperature will be then maintained until the next program step.

Advance mode can be used to advance to the next program. To do this, press PROG whilst in AUTO mode. To clear advance mode, press PROG. The program currently active is indicated in the top left of the display.

Information on how to set up the program schedule can be found on pages 7 & 8.



## Heat symbol

Every time there is a demand for heat, the display will show the heat icon.



Full heat



Half heat (RX only)

## Keys locking

Press and hold TIME and TEMP together for 5 seconds. The display will show the symbol.  Repeat the step to unlock.



## Open Window Detection

Ensuring you don't waste energy on heating the outside world, the heater is equipped with optional open / closed window detection. The heater recognises sudden drops in temperature when a window or a door is opened and turns the heating off to save energy. When the window is closed, the heater will automatically detect a temperature rise, and switch itself back on. Once enabled in the setup menu, the open window detection is fully automatic and does not require any human intervention to be activated. When open window detection has been triggered, the heat symbol will flash on/off as shown below.



### Setting-up Open Window Detection

The system has been factory set to default time and temperature values. If necessary, all values can be adjusted. When the heating is on, open window detection sensor will automatically switch the heater off when it detects a fall in temperature of 2°C in less than 10 minutes (this temperature can be changed in menu 8 and time in menu 7). If a temperature rise of 2°C in less than 30 seconds is detected, the heater will switch itself back on (this temperature can be changed in menu A and time in menu 9).

## Displaying the time/temperature

The HHPS01 can display either the time & day or the room temperature when in one of the 4 standard operating modes.

Press the TIME button to alternate between the two options.

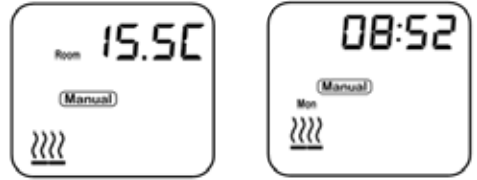

## Setting the time and day

To set the time and day, follow the steps below;

**Step 1:** Press and hold the TIME button for 5 seconds. The minutes will flash. Use the + and - buttons to adjust the minutes.



**Step 2:** Press the TIME button. The hours will flash. Use the + and - buttons to adjust the hours.



**Step 3:** Press the TIME button. The day will flash. Use the + and - buttons to change the day. Once set, press the TIME button to return to the main screen.



# Setting the automatic program schedule

## An example of one day program on HHP501

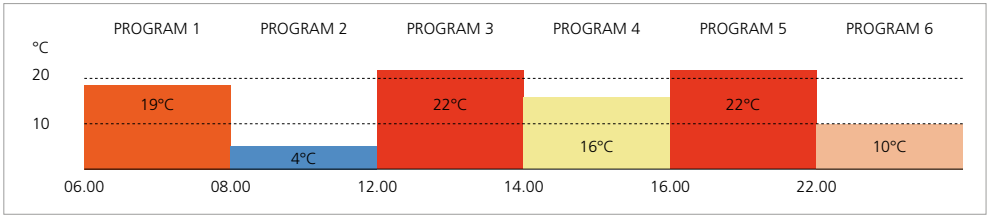

### Logic diagram for setting program on HHP501

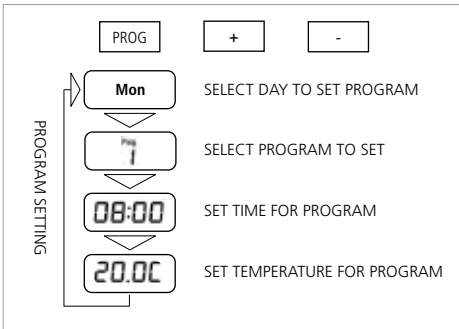

This section provides an example of how to set the 7-day program for one day. The example will program the timer to maintain 21°C from 08:00 until 16:00. It will maintain 4°C from 16:00 onwards; It does this by setting the programs as follows;

**Prog 1** - Set to 08:00 and 21°C

**Prog 2** - Set to 16:00 and 4°C

**Prog 3, 4, 5, 6** - Set to inactive

The steps to program this are shown below;

**Step 1:** Press and hold the PROG button. The display below should show with Monday flashing



**Step 2:** Press the PROG button. Prog 1 in the top left of the display should flash. This represents the program number. Each day has 6 programs.



**Step 3:** Press the PROG button. The time should flash. Use the + and - buttons to set the time you want the heating to switch on.



**Step 4:** Press the PROG button. The temperature should flash. Use the + and - buttons to set the temperature you want to maintain.



**Step 5:** Press the PROG button. Monday should flash again.



**Step 6:** Press the PROG button. Prog 1 in the top left of the display should flash. Use the + button to increment this to Prog 2. (Note: you can cycle between the different programs using the + and - buttons)



**Step 7:** Press the PROG button. The time should flash. Use the + and - buttons to select the time you want the heating to switch off.



**Step 8:** Press the PROG button. The temperature should flash. Use the + and - buttons to select a frost protection temperature.



**Step 9:** Repeat these steps for programs 3-6 if additional time periods are required. Any programs not being utilized must be deactivated. To do this, simply select the program in question as per step 6 and press the TIME button. The time should change to dashes as shown below. To reactivate the program, simply press the TIME button again.

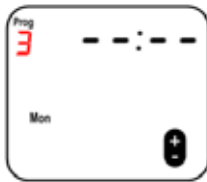

## Automatic program overview

The HHPS01 has a 7-day, 5-day 2-day and a 24 hour timer available. This can be chosen in the setup menu. Up to 6 programming steps are available for each day. In the programming you can set a start time and a temperature for each program.

## Basic operation

1. Press and hold PROG for 5 seconds to enter the program setting.
2. The day will be flashing. Use + and - to navigate day, press PROG to select day.
3. PROG 1 will be flashing. Use + and - to navigate program, use PROG to select program.
4. The time will be flashing. To set time, use + and -, press PROG to set the time.
5. The temperature will be flashing. To set temperature, use + and - to change temperature, press PROG to set temperature.

To add another program repeat steps 2-10.

## Set program inactive

If you do not require the use of all 6 programs they can be deactivated. When in programming mode select the program you want to make inactive and press the TIME button. To activate the program again, press the TIME button.

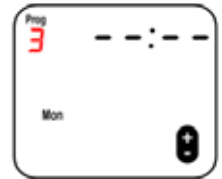

## Copy day function

If you require the same set of programs throughout the week, a 24 hour timer is available. This will use the same program every day. A 5-day + 2-day timer is also available. This will use the same programs Monday-Friday, and the same programs Saturday and Sunday. These modes are enabled in the setup menu, as explained on page 9.

Alternatively, it is possible to copy a program from one day to another. To do this, follow the steps below;

**Step 1:** Press and hold PROG for 5 seconds to enter the program setting.



**Step 2:** Press and hold TIME for 5 seconds to enter the copy day setting.



**Step 3:** Use the PROG button to select the day to copy the programs from. 1= Monday, 2 = Tuesday and so on.



**Step 4:** Use the + and - buttons to select the day to copy the programs to.



**Step 5:** Press the TIME button to copy the programs. The 'TO' will flash to confirm the programs have been copied.



## Setup menu

1. Press and hold TEMP and MODE together for 5 seconds.
2. The display will enter the setup menu.
3. Use + and - to change a value.
4. Use TIME to scroll between the settings.
5. Use PROG to exit the setup menu

### 1 - Temperature calibration

The temperature reading is factory calibrated but if for any reason it needs adjusting (better accuracy required, to suit different position in the room etc.), the reading can be recalibrated in 0.5 degree steps.



### 3 - Adjust fan speed

(Select models only. Does not apply in manual control mode)

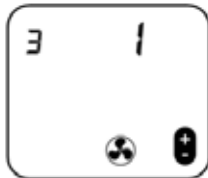

### 4 - Set minimum temperature



### 5 - Set maximum temperature



### 6 - Enable/disable open window detection



### 7 - Open window detection time



### 8 - Temperature drop in open window detection time



### 9 - Closed window detection time



### A - Temperature rise in closed window detection time



### B - Program mode select.

Choose between a 7-day, 5-day 2-day or a 24 hour timer.

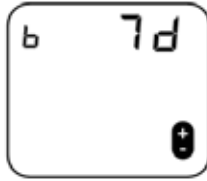

### C - Select operating mode:

1 = temperature control  
2 = manual control

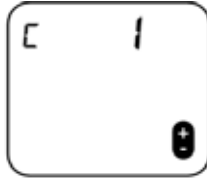

### D - Enable/disable SL wireless signal



### E - Compatibility modes:

0 = Normal operation

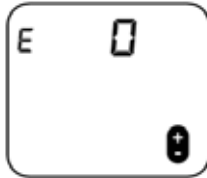

## Choosing a position in a room

When using the HHPS01 for temperature control, a suitable position in the room should be chosen. Avoid areas with draught or direct sun. Do not position HHPS01 above or close to the heaters or other heat sources. Damp areas or areas where HHPS01 can be mechanically damaged should also be avoided. Typically 1.2 to 1.5m above floor level.

## Installing the controller

The controller can be left free-standing or mounted to the wall in a suitable location.

To mount the controller to the wall, the supplied wall bracket should be used. Install the bracket using the 2 screw holes provided as shown in the image.

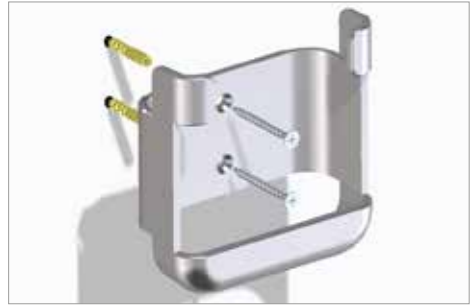

The bracket acts as a holder for the controller. The controller can be removed from the bracket easily to operate as a handheld device. Alternatively, a locking screw can be attached from the bottom of the device to permanently fix the controller to the bracket.



## Batteries

The HHPS01 is battery powered. Remove the battery cover and insert 2 new high quality alkaline AA batteries.

**Warning:** Smith's is not responsible for damage due to corrosion. Battery leakage will cause permanent damage.

To help avoid battery leak:

- Replace the batteries annually, even if there is not a low battery warning. Remove failing or flat batteries immediately.
- Always fit new high quality alkaline batteries from the same pack. Never mix new and old batteries, or batteries of different brands or types.
- Never attempt to revive alkaline batteries by heating, crushing or recharging.

**Note:** The clock has to be reset after replacing the batteries. The program settings will be remembered.



# Registering your product

Thank you for purchasing a Smith's product. It has been designed and manufactured to the highest quality standards to ensure it gives you efficient and trouble-free service for many years. To back up our commitment, included with your product is the following warranty:

## 5 years from date of purchase

This gives you the peace of mind that in the unlikely event of product failure, we will repair or replace the product completely free of charge providing the product has been installed, used and maintained in accordance with the instructions. Your statutory rights are not affected by this warranty.

It is important to register as soon as possible online at: [smithsep.co.uk/product-registration/](http://smithsep.co.uk/product-registration/). This will ensure you will receive prompt and efficient service if your product requires attention within the warranty period. If you do not register your product, you will be required to produce proof of purchase prior to receiving service.

For more details please visit our website: [SmithsEP.co.uk](http://SmithsEP.co.uk)

SCAN HERE TO REGISTER  
YOUR PRODUCT



# Disposal

As part of the policy of continuous product improvement, Smith's Environmental Products LTD reserves the right to alter specification without prior notice.

Products with this symbol (crossed out wheellie bin) cannot be disposed as household waste. Old electrical and electronic equipment must be recycled at a facility capable of handling these products and their waste by-products. If you are purchasing replacement equipment your retailer may offer a 'take back' scheme, or will be able to give details of the nearest approved authorised treatment facility. Proper recycling and waste disposal will help conserve resources whilst preventing detrimental effects on our health and the environment.

WEEE Registered Code: WEE/ED0093VW



# After sales and spares

If you experience any problems with the use of your product, please contact our after-sales office +44 (0) 1245 324560.

For product information, customer services or sales support call us on +44 (0) 1245 324900

For the Republic of Ireland, contact MT Agencies on 01 864 3363

Sales: [sales@SmithsEP.co.uk](mailto:sales@SmithsEP.co.uk)

General information: [info@SmithsEP.co.uk](mailto:info@SmithsEP.co.uk)

Smith's Environmental Products Ltd  
Blackall Industrial Estate, South Woodham Ferrers,  
Chelmsford, Essex CM3 5UW

[SmithsEP.co.uk](http://SmithsEP.co.uk)

[@SmithsEP\\_UK](https://twitter.com/SmithsEP_UK)

[#ThinkSmiths](https://www.facebook.com/ThinkSmiths)







### Happy to help

Smith's Environmental Products Ltd is one of the leading manufacturers of heating and cooling products in the UK. We are committed to achieving the highest standards and our faith is supported by a free parts and labour guarantee with every product. Our customer service is second to none and we are happy to offer any help and guidance that you might need.

### Stockists

All products are available nationally from Builders' Merchants, Plumbers' Merchants, Heating Equipment Distributors and Kitchen Equipment Distributors. In the event of difficulty, please contact us or visit our website [SmithsEP.co.uk](http://SmithsEP.co.uk) for details of your nearest stockist.

### Information and advice

Full technical specifications and list prices is available to download from our website or in hard copy from our office. Also available on our website are price lists, individual product data sheets, installation & user guides, where to buy, who to contact and a media centre.

Alternatively contact our office 9.00am to 5.00pm Monday to Friday.

As part our commitment to continuous improvement Smith's Environmental Products may change the specifications of its products without prior notification or public announcement. All descriptions, illustrations, drawings and specifications in this publication present only general particulars and shall not form part of any contract. All dimensions are in mm unless otherwise stated.

**To view the full product information download the datasheet at:**  
**[www.SmithsEP.co.uk](http://www.SmithsEP.co.uk)**

For product information, customer services or sales support call us on **+44 (0) 1245 324900**

For the Republic of Ireland, contact MT Agencies on 01 864 3363

**Sales: [sales@SmithsEP.co.uk](mailto:sales@SmithsEP.co.uk)**  
**General information: [info@SmithsEP.co.uk](mailto:info@SmithsEP.co.uk)**

Smith's Environmental Products Ltd  
Blackall Industrial Estate, South Woodham Ferrers,  
Chelmsford, Essex CM3 5UW

**[SmithsEP.co.uk](http://SmithsEP.co.uk)**

**[@SmithsEP\\_UK](https://twitter.com/SmithsEP_UK)**

**[#ThinkSmiths](https://www.facebook.com/ThinkSmiths)**

85-0063 | Issue 001 | March 2024