

# Space Saver

Installation, commissioning  
and user manual

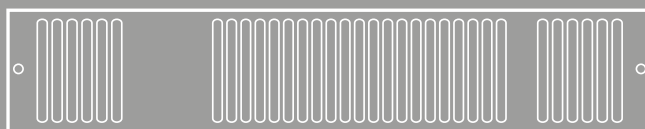

SS2E | SS3E | SS80E | SS5 DUAL

# Contents

Introduction	2
Declaration of conformity	2
Symbols used in this guide	3
Important safety and installation instructions	3/4
Application	4
Product Information	5
Installation - Heater	7
Installation - Controller	8
Pairing - Controller with Heaters	9
Commissioning	10
Installation - with advanced features	12
Commissioning	14
Fault finding	14
User Manual	
Important safety guidance	16
Introduction	17
Operation	18
Fault finding	26
Registering your product	27
Disposal	27
After sales and spares	27

## Introduction

The following items are included in the carton:

- Product complete with overlay grille and pre-wired mains cable
- Fixing screws (2)
- Wireless controller
- One pair of flexible hoses (SS5 Dual only)

Accessory grilles which fit in place of standard grille are available in different colours and finishes. Please consult the price list for details. In the event of any items missing or visible damage, please contact us on +44 (0) 1245 324560.

Please leave this Installation and User Manual with the owner of the property.

## Declaration of conformity

EC Declaration of conformity  
We, Smith's Environmental Products Limited  
1-2 Blackall Industrial Estate  
South Woodham Ferrers  
Chelmsford  
Essex CM3 5UW  
Tel: 01245 324900 Fax: 01245 324422

Declare under sole responsibility that the products:

Product name:  
**Space Saver**

Product range:  
**SS2E, SS3E, SS80E, SS5 DUAL**

Listed above confirms with the following European Union directives:  
**Low Voltage Directive (73/23/EEC)**  
**EMC Directive (89/336/EEC)**  
**Pressure Equipment Directive (97/23/EC)**  
**Machinery (98/37/EC)**

Standards comply with the above directives.

Safety Directive Standards:  
**EN 60335-2-80:2003 + A1:04 in conjunction with EN 60335-1:2002 + A11:04 + A1:04 + A12:06 + A2:06**  
**With UK deviations**

This Declaration is made on behalf of Smith's Environmental Products Limited by:

Jim Bennett  
Global Sales and Marketing Director

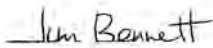

# Symbols

This manual contains information and prescriptions marked by the following symbols:



Ignoring these safety provisions marked by the symbol "caution: hazard" may endanger the safety of people.



Ignoring these safety provisions marked by the symbol "caution: electricity" may endanger the safety of people, as well as the integrity of the equipment.



High temperature surface. Take utmost care to prevent people from getting in contact with the hot surfaces of the appliance.

## Important safety and installation instructions

Prior to installation, read these installation and operating instructions. The installation and operation should also be in accordance with national regulations and accepted codes of good practice.



This appliance is not intended for use by persons (including children) with reduced physical, sensory or mental capabilities, or lack of experience and knowledge, unless they have been given supervision or instruction concerning use of the appliance by a person responsible for their safety. Children should be supervised to ensure that they do not play with the appliance.

To guard against injury, basic safety precautions should be observed, including the following:

1. Read and follow all safety instructions and all the important notices on the appliance before installing, using and maintaining the appliance. Failure to do so may cause personal injury or damage to the appliance or installation.
2. Always disconnect electrical supply before putting on or taking off parts and whilst the equipment is being installed, maintained or handled. Never work with bare feet and/or with wet hands.
3. Carefully examine the appliance before and after installation.  
Do not operate the appliance if it has a damaged supply cord or enclosure, or if it is malfunctioning or it is dropped or damaged in any manner. Inspect the appliance periodically.



4. Improper use.

Do not use this appliance:

- In locations where special conditions prevail, such as the presence of a corrosive or explosive atmosphere (dust, vapour or gas) (EN60335-2-51);
- For other than intended use.



5. Installation.

The appliance must be mounted in a stable/fixed position in a dry, well ventilated, frost-free, waterproof and protected place, with sufficient ventilation around it. Make sure that the appliance is securely and correctly installed before operating it and that there is enough room around it for maintenance operations, dismantling, checking for free inspection.

The maximum ambient temperature at which the appliance is to be used is 40°C (EN60335-2-51).

# Important safety and installation instructions

Prior to installation, read these installation and operating instructions. The installation and operation should also be in accordance with national regulations and accepted codes of good practice.



## 6. Electrical connection

**IMPORTANT:** Connection to the power supply must be effected by means of a fixed power cable which is fitted with a plug-type connection or a two pole isolating switch with a minimum contact opening of 3 mm.

Electrical connection must be carried out by a qualified electrician and in accordance with local regulations and both data on the name-plate and the appropriate diagram inside the terminal box cover.

Follow all safety standards.

7. Connect the appliance only to a mains supply protected by a Residual Current Device (RCD or Ground-Fault Circuit-Interrupter) with a rated residual operating current not exceeding 30mA.
8. Prior to any modification being made to the equipment, it must be agreed with and authorised by the manufacturer. Original spare parts and accessories authorised by the manufacturer are integral part contributing to the safety of the equipment and of the machines. The use of non original components or accessories may endanger the safety and causes the termination of the warranty. Safe operation is only assured for the applications and conditions described in Application of this manual.

Non-observance of the safety instructions results in the loss of any claims to damages.

The indicated limit values are binding and cannot be exceeded for any reason whatsoever.

KEEP THESE INSTRUCTIONS FOR FUTURE REFERENCE.

## Application

Space Saver is primarily intended for installation in the space beneath kitchen cupboards behind the plinth. However, it can be also installed in similar applications such as stair cases and other built-in furniture.

This Space Saver model must NOT be installed in a bathroom or other areas of high humidity. Please contact us on +44 (0) 1245 324560 for details of products suitable for these applications.

In compliance with LOT20 European legislation, this product is supplied with a wireless battery powered wall-mounted time and temperature controller. This heater will NOT function without the wall-mounted controller. The controller can control an unlimited number of heaters.

Space Saver is fitted with an overheat protection. The heater will automatically stop in the event of the heating elements reaching the cut-out temperature.

SS5D dual models are designed for use on standard two -pipe pumped central heating systems. Pipes are 15mm and either may be used as flow or return. The product is not suitable for one-pipe systems.

Please note the guarantee may be invalidated if this product is not installed and used in accordance with this guide.

# Product dimensions and performance

## SS2E

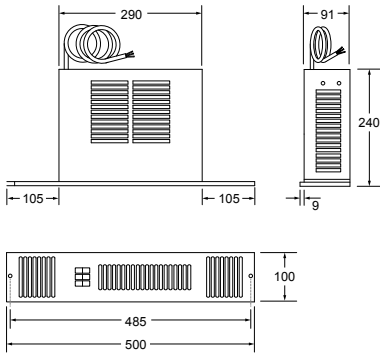

### Heat output

Heat Output (kW)	Power Consumption (kW)	Fused spur	Mains Cable (m)
1kW/2kW	1kW/2kW	10A	2.0

Voltage: 230V

## SS3E

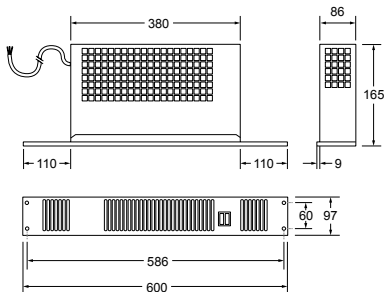

### Heat output

Heat Output (kW)	Power Consumption (kW)	Fused spur	Mains Cable (m)
1kW/2kW/3kW	1kW/2kW/3kW	13A	2.0

## SS80E

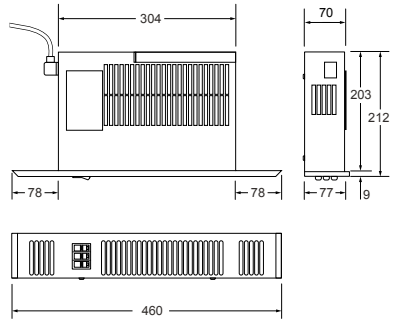

### Heat output

Heat Output (kW)	Power Consumption (kW)	Fused spur	Mains Cable (m)
0.6kW/1.2kW	0.6kW/1.2kW	10A	2.0

# Product dimensions and performance

## SS5 DUAL

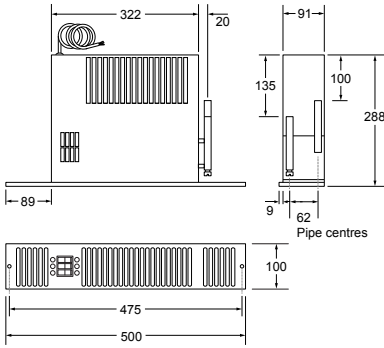

### Heat output - electric mode

Heat Output (kW)	Power Consumption (kW)	Fused spur	Mains Cable (m)
1kW	1kW	5A	2.0

### Heat output - hydronic mode

It is recommended that the Space Saver model chosen is capable of maintaining the calculated heat loss at normal heat output (I) enabling the boost setting (II) to be used for faster heat up.

Model	Room size guide* (m <sup>3</sup> )	Heat Output at 80°		Heat Output at 75°		Heat Output at 70°		Heat Output at 65°	
		Normal (kW)	Boost (kW)	Normal (kW)	Boost (kW)	Normal (kW)	Boost (kW)	Normal (kW)	Boost (kW)
<b>Hydronic/Electric (Dual)</b>									
SS5 Dual (hydronic mode)	37	1.3	1.7	1.2	1.6	1.1	1.4	1.0	1.3
SS5 Dual (electric mode)	29	1.0	-	1.0	-	1.0	-	1.0	-

Model	Room size guide* (m <sup>3</sup> )	Heat Output at 60°		Heat Output at 55°		Heat Output at 50°		Heat Output at 45°	
		Normal (kW)	Boost (kW)	Normal (kW)	Boost (kW)	Normal (kW)	Boost (kW)	Normal (kW)	Boost (kW)
<b>Hydronic/Electric (Dual)</b>									
SS5 Dual (hydronic mode)	37	0.9	1.1	0.8	1.0	0.7	0.9	0.6	0.8
SS5 Dual (electric mode)	29	1.0	-	1.0	-	1.0	-	1.0	-

\*Room sizes given in cubic metres for general guidance only based on normal heat output (80°C) for domestic applications - always calculate heat losses. Heat outputs tested in accordance with BS4856 using entering water temperature and 340 l/h (75gph) flow rate. Fan-only option operational only when central heating system is switched off. Dual models include an electric element which in electric heating mode will emit 1kW of heat. If the heating system comes on whilst the Space Saver is switched to electric heating mode, the element will automatically switch off. Using Hydronic heating mode where possible will considerably reduce running costs.

## WALL CONTROLLER

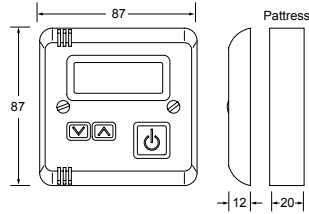

# Installation - Heater

## 1. Cut the opening in the plinth

- To ensure adequate airflow, a minimum clearance of 20mm (10mm for SS80E product) between the top of the product and any shelving is essential
- To avoid the possibility of vibration, this product must be installed on a flat, even surface
- There must be no rear access to the product after completion of the installation

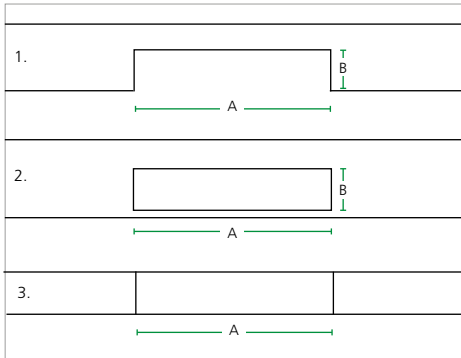

- We recommend the use of a knee pad when installing this product
- Cut the opening in the plinth to the size shown in the table. Use method 1 or 2. 3 represents installation into a 80mm plinth (SS80E only)

Model	Width A (mm)	Height B* (mm)
SS2E	475	96
SS3E	500	95
SS80	400	74
SS5 DUAL	465	96

\* The overall height of the grille is 100mm. Use care when cutting the opening.

## 2a. Connection for SS5 Dual Heater - Fit isolating valves (not supplied)

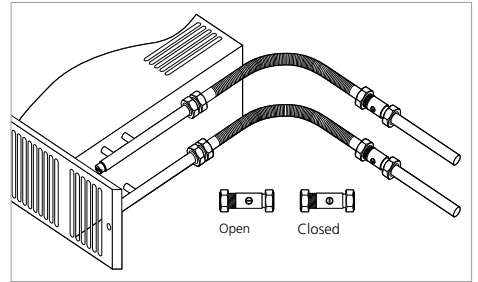

- Fit isolating valves (not supplied) to the system flow and return pipes. In order to achieve the highest level of performance we recommend full bore valves.
  - Failure to fit isolating valves may mean that the product is not serviceable in the event of failure.
  - Connect the flexible hoses between system pipework and heater. Please ensure the flexible hoses are not kinked.
  - Open the isolating valves and check for leaks.
- N.B. either pipe may be used on flow or return.

The Flexible installation hoses supplied are suitable for use with either 15mm diameter copper pipe or 15mm cross-linked polythene barrier pipe to BS 7291. The only type of fitting approved to connect onto the heater are compression fittings.

## 2b. Vent air through bleed

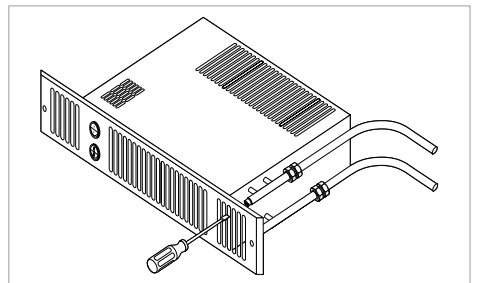

## 2c. Electrical connection - Heater

- Isolate the electrical supply and connect the heater electric cable to the fused spur
- The fused spur must not be directly above the heater, but should be accessible after completion of the installation

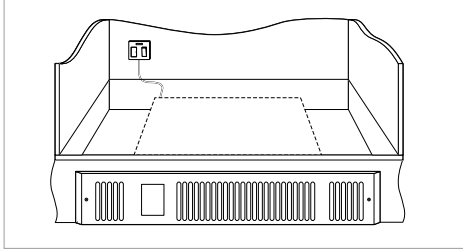

Electrical installation should be carried out by a competent installer, preferably registered with NICEIC (National Inspection Council for Electrical Installation Contracting) in accordance with the 17 edition of the IEE Wiring Regulations, (BS.7671), and any relevant Local Authority Bye-Laws. This heater is fitted with a 3-core mains supply cable and should be permanently connected to the electricity supply via a double pole switch having 3mm gap on each pole. A switched Fused Connection unit to BS.1363. Part 4 is a recommended mains supply connection accessory to ensure compliance with safety requirements applicable to fixed-wiring installation.

## 3. Position heater

- Position the heater, making sure the electrical cable is not snagged

## 4. Fix to plinth

- Fix heater to plinth

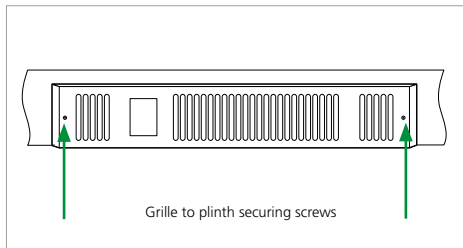

## 5. Overlay grille (optional)

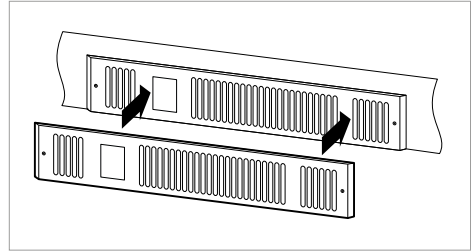

- If required fit the overlay grille
- Remove the screws holding the fixed grille to the plinth
- Place the overlay grille over the fixed grille and refit the screws

## Installation - Controller Introduction

In compliance with LOT20 European legislation, this product is supplied with a wireless battery powered wall-mounted time and temperature controller. The product will NOT function without the wall-mounted controller. The controller can control an unlimited number of heaters.

The controller is primarily designed to minimise energy wastage and ensure the room is maintained at the comfort level set by the user. In the basic setting, the controller is a simple room thermostat in which the heater will run until the set temperature is reached. If the room temperature falls the heater will switch on again until the set temperature is reached. The operating range is between 15°C and 35°C.

The controller also has a number of advanced features that, if required MUST be set during the installation process. Please discuss with your customer which features they require.

- **Temperature control for Comfort (COMF)**  
This can be set to limit the maximum temperature set by the user.
- **Temperature control for Setback (SETB)**  
This can be used for frost protection or situations where a minimum room temperature must be maintained. The setback temperature can be set between 0°C and 15°C.



- **Run-back Timer**

This can be used to limit the run time of the heater from between 5 minutes and 2 hours.

The Run-back Timer cannot be used in conjunction with Temperature control for Setback (SETB).

## 1. Choosing a position in a room for the wall controller

The Controller should be positioned 1.5m above the floor and in the same room/space as the heater.

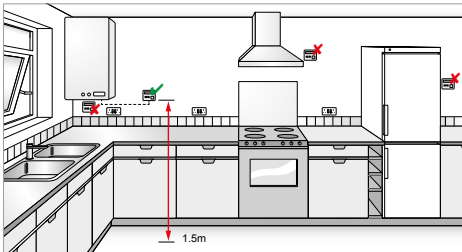

The controller should be fixed to the wall. Avoid areas with draft or direct sun. Do not position the controller above or close to the heaters or other heat sources. Damp areas or areas where the controller can be mechanically damaged should also be avoided. Avoid installing the controller in areas where there are metal objects between the heater and the controller. This will reduce the RF range. The RF range in ideal conditions can be up to 20m however this can be reduced when the signal is passing through the walls or other objects. The range can be also affected where the controller is mounted close to power cables, motors or equipment producing strong electromagnetic field. If the temperature control feature is used it is necessary to use one controller for each room or zone.

## 2. Installation - Basic Setting

The controller is supplied with a white plastic mounting box that needs to be fixed to a wall at 1.5m above floor level. The controller is powered by two AAA batteries, supplied. To activate the controller pull the plastic tab located at the + battery terminal. The batteries should be replaced every 12 months.

## Pairing controller with heaters

In order to pair your appliance with the controller:



1. On the back of the controller, you will see the battery compartment. Pull and remove the battery tag. Look at the front display. If the batteries are good, the front battery display will show the temperature.



2. Turn the power to the appliance ON, and within **20 seconds** press and hold, the ON button on the controller until the display shows "PAIR"



3. After the pairing is finished, the display will show "TEST". If the pairing was successful, the appliance should function (This can take up to 5 seconds after pairing)

If process fail repeat all the steps again



4. Press the ON button to exit pairing

# Commissioning

## SS2E

1. Before switching the heater on, please ensure the fascia grille is free from obstruction
2. Ensure your fused spur is switched ON
3. Ensure the heater is paired with the wireless controller
4. Ensure the controller is switched on and calling for heat
5. Set the upper fan switch and the middle 1kW switch to ON
6. If you require a faster warm up, set the lower 2kW switch to ON. Please note all switches must be in the ON position to achieve 2kW output
7. To turn the heater OFF, set the controller switch to OFF (heating symbol not shown on display)

For your safety this Space Saver heater is fitted with an automatic overheat protection. If the heater stops, turn off the power at the fused spur, wait 5 minutes and switch the power back on.

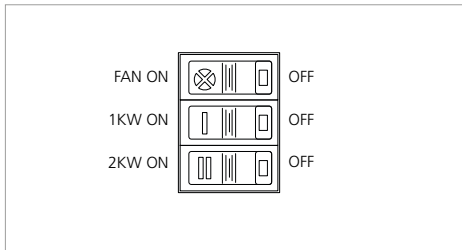

## SS3E

1. Before switching the heater on, please ensure the fascia grille is free from obstruction
2. Ensure your fused spur is switched ON
3. Ensure the heater is paired with the wireless controller
4. Ensure the controller is switched on and calling for heat
5. A. For 1kW heat output press left hand switch only (switch illuminates)  
B. For 2kW heat output press right hand switch only (switch illuminates)  
C. For 3kW heat output press both switches (switches illuminate)
6. To turn the heater OFF set the controller switch to OFF (heating symbol not shown on display)

Space Saver is fitted with an electronic safety (ES) control which is a safety device which switches off the heater, if for any reason, the appliance overheats. The ES controls can only be reset after the appliance has cooled down in order to reset the ES control see fault finding.

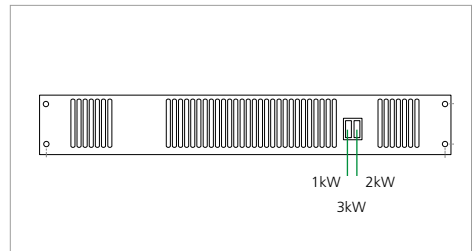

## SS80E

1. Before switching the heater on, please ensure the fascia grille is free from obstruction
2. Ensure your fused spur is switched ON
3. Ensure the heater is paired with the wireless controller
4. Ensure the controller is switched on and calling for heat
5. Set the upper fan switch and the middle switch 600W to the ON position
6. If you require a higher heat setting then set the bottom 1200W switch to the ON position
6. To turn the heater OFF set the controller switch to OFF (heating symbol not shown on display)

For your safety this Space Saver heater is fitted with an automatic overheat protection. If the heater stops, turn off the power at the fused spur, wait 5 minutes and switch the power back on.

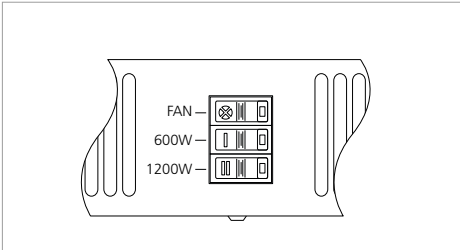

## SS5 DUAL

1. Before switching the heater on, please ensure the fascia grille is free from obstruction
2. Ensure your fused spur is switched ON
3. Ensure the heater is paired with the wireless controller
4. Ensure the controller is switched on and calling for heat
5. Set the upper rocker switch on the fascia grille to the right (blue) and the lower switch to the left or right - the fan should run
6. Set the upper rocker switch to the left (red) and the middle rocker switch to the right (electric heating). Heat will start to flow immediately. Increasing the fan speed will not increase the heat output in the electric heating mode
7. Turn on the central heating system
8. Set the upper rocker switch to the left (red), the middle rocker switch to the left (hydronic heating) and the lower switch to the left (normal output). The fan should run and heat will flow within a few minutes
9. Balance the central heating system if Space Saver is installed on the same circuit as panel radiators
10. To turn the heater OFF set the controller switch to OFF (heating symbol not shown on display)

For your safety this Space Saver heater is fitted with an automatic overheat protection (electric mode only). If the heater stops, turn off the power at the fused spur, wait 5 minutes and switch the power back on.

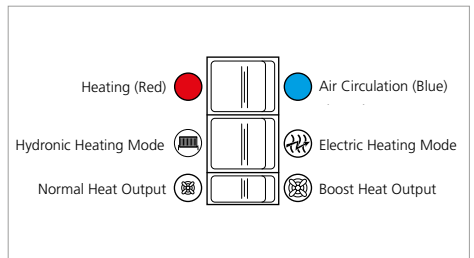

# Installation - with advanced features

## 1. Getting to know your battery controller

The controller has a number of advanced features that, if required **MUST** be set during the installation process. Please discuss with your customer which features they require. The dip switches will need to be set prior to attaching the thermostat to the back box.

- Temperature control for Comfort (COMF)**  
 This can be set to limit the maximum temperature set by the user.
- Temperature control for Setback (SETB)**  
 This can be used for frost protection or situations where a minimum room temperature must be maintained. The setback temperature can be set between 0°C and 15°C.
- Run-back Timer**  
 This can be used to limit the run time of the heater from between 5 minutes and 2 hours.

The Run-back Timer cannot be used in conjunction with Temperature control for Setback (SETB).

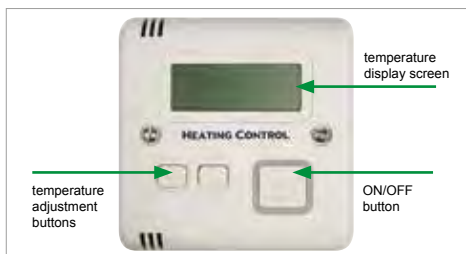

Radio transmit symbol will flash every time a signal is sent

Heating status symbol  
**Solid** - heating active  
**flashing** - heating inactive, room at set temperature  
**not shown** - heating inactive

**Temperature not flashing** - indicating room temperature  
**Temperature flashing** - indicating set temperature when using UP or DOWN buttons

Temperature can be displayed in °C or °F. This can be changed by SW1.

## 2. Temperature control for Comfort (COMF)

Switch 1 controls the display screen. If it is set to 'ON' the temperature is displayed as Fahrenheit. If it is set to 'OFF' the temperature is displayed as Celsius.

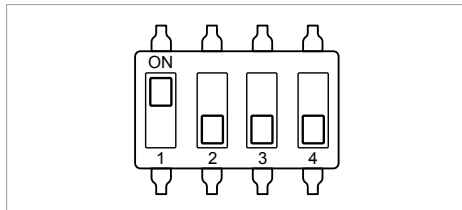

Prior to installation the maximum comfort temperature can be adjusted using the knob marked COMF located at the back of the controller as shown below. The range is 15°C to 35°C. The maximum comfort temperature limits the temperature that can be set by users after installation. After installation, the user can adjust the temperature using the UP and DOWN buttons, in the range from 15°C up to the maximum temperature set by the knob marked COMF.

After pressing the 'ON' button the heating will operate until the set room temperature is achieved, at this point the heating status symbol on the display will start flashing. When the room temperature drops the heating will become active again and the heating status symbol will change from flashing to steadily on.

The display screen will show the actual room temperature, except briefly when either of the two adjustment buttons are pressed, the new target room temperature is then temporarily displayed.

Note: After changing any settings, in order for the change to take place, the controller has to be set to heating inactive status.

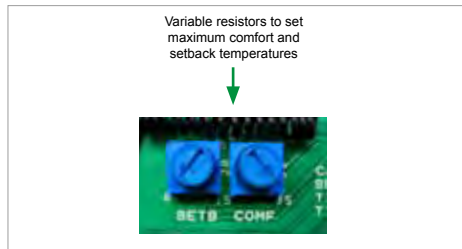

### 3. Temperature control for Setback (SETB)

For this mode, the switches are set as shown below.

In this mode, the controller will set heating active when the room temperature drops below the set temperature. This feature can be used for frost protection or in situations where a minimum room temperature must be maintained. The setback temperature can be set using the knob marked SETB mounted on the back of the unit as shown bottom of page 12. This can be set from 0°C - 15°C.

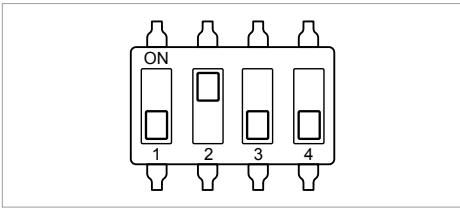

If the heating is active in the setback mode, the display will show the heating status symbol and the temperature will flash steadily.

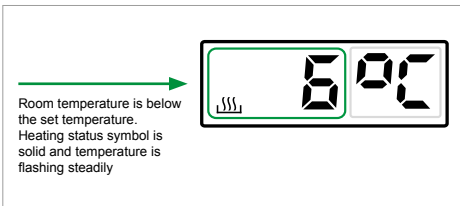

Temperature control for comfort and setback periods can be used individually or together. This can also be used in conjunction with the timer mode options.

### 4. Run-back Timer

For timer mode, the switches are set as shown below.

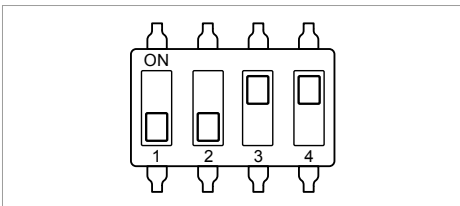

In timer mode, switch 3 or 4 must be in the 'ON' position. This mode allows for 3 different settings which will alter the time period for each segment.

- Switch 3 - Each time period represents 5 minutes
- Switch 4 - Each time period represents 15 minutes
- Switch 3 & 4 - Each time period represents 30 minutes

#### Controller functionality in timer mode:

In timer mode, the controller acts as a 4 stage run-back timer. When the controller is in stand-by mode and button is pressed, the display will show 0h00. When pressed again the display will show time for the first stage of the run back timer in minutes and heating is activated. When pressed again the display will show time for the second stage and so on. Each stage is representing a time period that is selected when setting the switches.

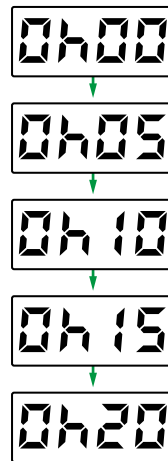

In the example, the only switch in the 'ON' position would be number 3. The button would be pressed four times to activate four 5-minute segments resulting in the heater staying on for 20 minutes. At the end of the last time period the controller is now in stand-by mode.

If the 'ON' button is pressed the display will show remaining time. The remaining time can be increased at any time by pressing the 'ON' button.

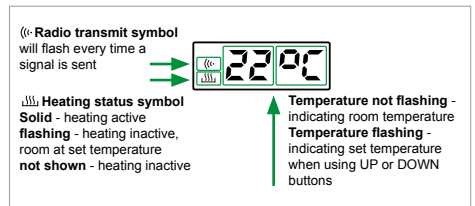

#### Batteries

Is recommended that the battery is changed every 12 months to protect potential damage by batteries leaking (batteries are supplied with the controller)

You do not need to re-pair after batteries have been changed (pairing is done by programming the chip memory)

# Commissioning - see page 10

## Fault finding

In the event of any difficulty, please contact us on +44 (0) 1245 324560.

Fault	Checking/Solution
Fan does not run/no heat output	<ul style="list-style-type: none"><li>Check the power supply is switched ON</li><li>Check fuse in fused spur</li><li>Check the fan switch is set to ON</li><li>Check the battery in the controller and replace if necessary</li><li>Check the wireless controller thermostat is calling for heat</li><li>Check the thermostat and controller is paired to the heater</li></ul>
Fan does not run/no heat output on central heating mode (SS5 Dual only)	<ol style="list-style-type: none"><li>1. If possible check that both of the copper pipes on the side of the unit are hot</li><li>2. Ensure the flexible connections are not kinked</li><li>3. Balance the central heating system if installed on the same circuit as panel radiators and increase the circulating pump speed if required</li><li>4. Increase the boiler water temperature</li><li>5. Check the service valves are open</li><li>6. Bleed air from the appliance</li></ol>
If the overheat protection has activated, manual reset as follows:	<ol style="list-style-type: none"><li>1. Switch the power supply OFF at the fused spur</li><li>2. Wait 5 minutes for the overheat cut-out switch to reset</li><li>3. Switch the power supply on</li></ol>

### Wireless Controller Self Diagnostic

The controller is equipped with a self diagnostic software that will check functionality of all main components. If there is a fault with any part of the controller or controller is operating outside of the temperature limits, the display will show 'Err' on the display. If this happens, controller will not function in order to protect itself and the heaters.

# Space Saver

User manual

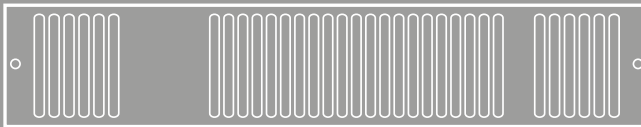

SS2E | SS3E | SS80E | SS5 DUAL

# Important safety and installation instructions

Please read this user manual before operating this appliance. The operation should also be in accordance with national regulations and accepted codes of good practice.



This appliance is not intended for use by persons (including children) with reduced physical, sensory or mental capabilities, or lack of experience and knowledge, unless they have been given supervision or instruction concerning use of the appliance by a person responsible for their safety. Children should be supervised to ensure that they do not play with the appliance.

To guard against injury, basic safety precautions should be observed, including the following:

1. Read and follow all safety instructions and all the important notices on the appliance before installing, using and maintaining the appliance. Failure to do so may cause personal injury or damage to the appliance or installation.
2. Always disconnect electrical supply before putting on or taking off parts and whilst the equipment is being installed, maintained or handled. Never work with bare feet and/or with wet hands.
3. Carefully examine the appliance before and after installation.  
Do not operate the appliance if it has a damaged supply cord or enclosure, or if it is malfunctioning or it is dropped or damaged in any manner. Inspect the appliance periodically.



4. Improper use.

Do not use this appliance:

- In locations where special conditions prevail, such as the presence of a corrosive or explosive atmosphere (dust, vapour or gas) (EN60335-2-51);
- For other than intended use.

5. Installation.

The appliance must be mounted in a stable/fixed position in a dry, well ventilated, frost-free, waterproof and protected place, with sufficient ventilation around it. Make sure that the appliance is securely and correctly installed before operating it and that there is enough room around it for maintenance operations, dismantling, checking for free inspection.

The fascia grille must be free from obstruction.

The maximum ambient temperature at which the appliance is to be used is 40°C (EN60335-2-51).



## Warnings (Controller)

- Do NOT handle the appliance with wet hands.
- Do NOT use the appliance in workshops or rooms where excessive dust is generated or present.
- Ensure that nothing is pushed into any aperture of this controller.
- Do NOT cover or restrict any aperture
- Do NOT use the appliance if damaged.
- Do NOT use in a bathroom
- Operating temperature range -10 to +40°C.



# How it works - Heater

Cooler air is drawn in by the fan and heated as it passes through the heating element before being discharged gently back into the room. This not only gives a more even temperature spread, but will heat up a room quicker than a traditional panel radiator.

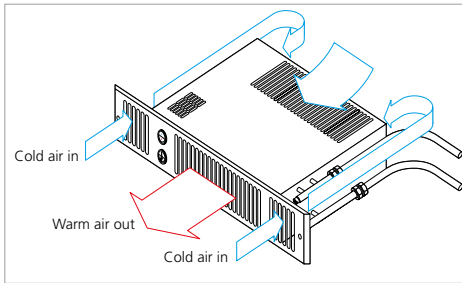

# Introduction

In compliance with LOT20 European legislation, this product is supplied with a wireless battery powered wall-mounted time and temperature controller. The product will NOT function without the wall-mounted controller. The controller can control an unlimited number of heaters.

The controller is primarily designed to minimise energy wastage and ensure the room is maintained at the comfort level set by the user. In the basic setting, the controller is a simple room thermostat in which the heater will run until the set temperature is reached. If the room temperatures falls the heater will switch on again until the set temperature is reached.

The operating range is between 15°C and 35°C.

The controller has a number of advanced features that, if required MUST be set during the installation process. Please discuss with your customer which features they require. The dip switches will need to be set prior to attaching the thermostat to the back box.

- **Temperature control for Comfort (COMF)**  
This can be set to limit the maximum temperature set by the user.
- **Temperature control for Setback (SETB)**  
This can be used for frost protection or situations where a minimum room temperature must be maintained. The setback temperature can be set between 0°C and 15°C.

- **Run-back Timer**  
This can be used to limit the run time of the heater from between 5 minutes and 2 hours.

The Run-back Timer cannot be used in conjunction with Temperature control for Setback (SETB).

## Wall Controller



## Batteries in Wall Controller

It is recommended that the battery is changed every 12 months to protect potential damage by batteries leaking (batteries are supplied with the controller)

You do not need to re-pair after batteries have been changed (pairing is done by programming the chip memory)

# How to operate

## SS2E

### Basic setting enabled

1. Ensure your fused spur is switched ON
2. Ensure the wireless controller is switched ON
3. Switch the upper fan switch to ON
4. Ensure the wireless controller is paired (page 9) with the heater
5. Set the thermostat to the desired temperature
6. Set the middle 1kW switch to ON
7. If you require a faster warm up, also set the lower 2kW switch to ON

Please note all switches must be in the ON position to achieve 2kW output

8. To turn the heater OFF, set the controller switch to off (heating symbol not shown on display)

For your safety this Kitchen Heater is fitted with an automatic overheat protection. If the heater stops, turn off the power at the fused spur, wait 5 minutes and switch the power back on.

#### Air Circulation (Summer use)

Set the thermostat to maximum set the fan switch to ON ensure the 1kW and 2kW switches are set to OFF. Kitchen Heater will provide a cooling flow of air.

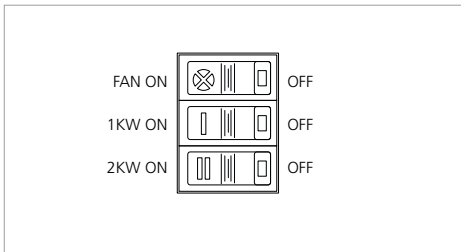

### Temperature control for Comfort (COMF) enabled

1. Ensure your fused spur is switched ON
2. Ensure the wireless controller is switched ON
3. Switch the upper fan switch to ON
4. Ensure the wireless controller is paired (page 9) with the heater
5. Set the thermostat to the desired temperature up to the maximum set during the installation process

6. Set the middle 1kW switch to ON

7. If you require a faster warm up, also set the lower 2kW switch to ON

Please note all switches must be in the ON position to achieve 2kW output

8. To turn the heater OFF, set the controller switch to off (heating symbol not shown on display)

For your safety this Kitchen Heater is fitted with an automatic overheat protection. If the heater stops, turn off the power at the fused spur, wait 5 minutes and switch the power back on.

#### Air Circulation (Summer use)

Set the thermostat to maximum set the fan switch to ON ensure the 1kW and 2kW switches are set to OFF. Kitchen Heater will provide a cooling flow of air.

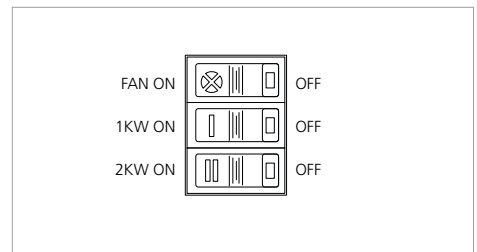

## Temperature control for Comfort (COMF) and Temperature control for Setback (SETB) enabled

1. Ensure your fused spur is switched ON
2. Ensure the wireless controller is switched ON
3. Switch the upper fan switch to ON
4. Ensure the wireless controller is paired (page 9) with the heater
5. Set the thermostat to the desired temperature up to the maximum set during the installation process
6. Set the middle 1kW switch to ON
7. If you require a faster warm up, also set the lower 2kW switch to ON

Please note all switches must be in the ON position to achieve 2kW output

8. If the temperature falls below the minimum temperature set (SETB) during installation the heater will switch ON automatically
9. To turn the heater OFF, set the wireless controller switch to off (heating symbol not shown on display)

For your safety this Kitchen Heater is fitted with an automatic overheat protection. If the heater stops, turn off the power at the fused spur, wait 5 minutes and switch the power back on.

### Air Circulation (Summer use)

Set the thermostat to maximum set the fan switch to ON ensure the 1kW and 2kW switches are set to OFF. Kitchen Heater will provide a cooling flow of air.

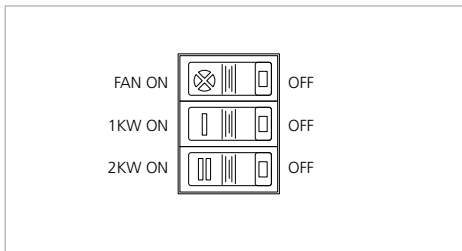

## How to operate – Run back Timer mode enabled

1. Ensure your fused spur is switched ON
2. Ensure the wireless controller is switched ON
3. Switch the upper fan switch to ON
4. Ensure the wireless controller is paired (page 9) with the heater
5. Set the thermostat to the desired temperature
6. Set the middle 1kW switch to ON
7. If you require a faster warm up, also set the lower 2kW switch to ON

Please note all switches must be in the ON position to achieve 2kW output

8. Press the wireless controller ON switch up to four times. The display will indicate the running time of the heater. If the heater reaches the desired temperature during the running time, it will switch off
9. To turn the heater OFF, set the wireless controller switch to off (heating symbol not shown on display)

Press the wireless controller ON switch up to four times. The display will indicate the running time of the heater. If the heater reaches the desired temperature during the running time, it will switch off.

For your safety this Kitchen Heater is fitted with an automatic overheat protection. If the heater stops, turn off the power at the fused spur, wait 5 minutes and switch the power back on.

### Air Circulation (Summer use)

Set the thermostat to maximum set the fan switch to ON ensure the 1kW and 2kW switches are set to OFF. Kitchen Heater will provide a cooling flow of air.

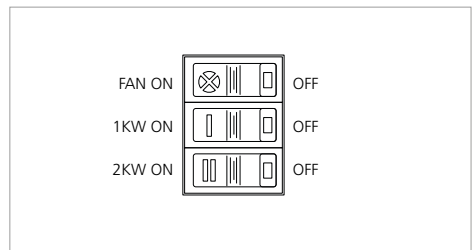

# How to operate

## SS3E

### Basic setting enabled

1. Ensure your fused spur is switched ON
2. Ensure the wireless controller is switched ON
3. Ensure the heater is paired with the wireless controller
4. Ensure the wireless controller is switched on and calling for heat
5. Switches on the right hand side of fascia control heat output:
  - A. For 1kW heat output press left hand switch only (switch illuminates)
  - B. For 2kW heat output press right hand switch only (switch illuminates)
  - C. For 3kW heat output press both switches (switches illuminate)
6. To turn the heater OFF set the controller switch to OFF (heating symbol not shown on display)

Space Saver is fitted with an electronic safety (ES) control which is a safety device which switches off the heater, if for any reason, the appliance overheats. The ES controls can only be reset after the appliance has cooled down in order to reset the ES control see fault finding.

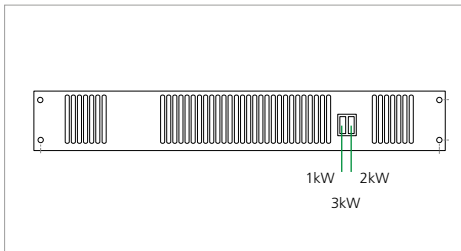

### Temperature control for Comfort (COMF) enabled

1. Ensure your fused spur is switched ON
2. Ensure the wireless controller is switched ON
4. Ensure the wireless controller is paired (page 9) with the heater
5. Set the thermostat to the desired temperature up to the maximum set during the installation process
  - A. For 1kW heat output press left hand switch only (switch illuminates)
  - B. For 2kW heat output press right hand switch only (switch illuminates)
  - C. For 3kW heat output press both switches (switches illuminate)
6. To turn the heater OFF, set the controller switch to off (heating symbol not shown on display)

For your safety this Kitchen Heater is fitted with an automatic overheat protection. If the heater stops, turn off the power at the fused spur, wait 5 minutes and switch the power back on.

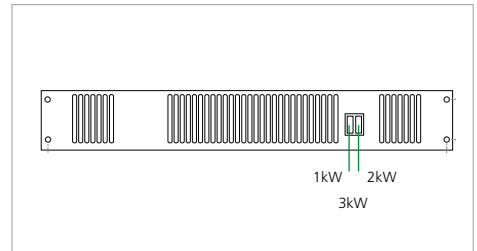

## Temperature control for Comfort (COMF) and Temperature control for Setback (SETB) enabled

1. Ensure your fused spur is switched ON.
2. Ensure the wireless controller is switched ON
3. Switch the upper fan switch to ON.
4. Ensure the wireless controller is paired (page 9) with the heater
5. Set the thermostat to the desired temperature up to the maximum set during the installation process
6. Set the left hand switch to ON (switch illuminates)
  - A. If you require a faster warm up, set the right hand switch only (switch illuminates)
  - B. For 3 kW press both switches (switches illuminate)
8. If the temperature falls below the minimum temperature set (SETB) during installation the heater will switch ON automatically
9. To turn the heater OFF, set the wireless controller switch to off (heating symbol not shown on display)

For your safety this Kitchen Heater is fitted with an automatic overheat protection. If the heater stops, turn off the power at the fused spur, wait 5 minutes and switch the power back on.

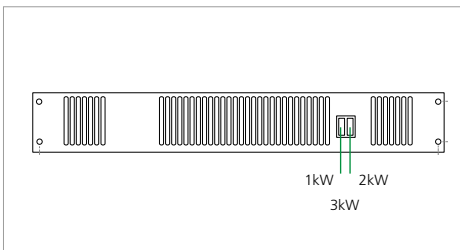

## How to operate – Run back Timer mode enabled

1. Ensure your fused spur is switched ON
2. Ensure the wireless controller is switched ON
3. Switch the upper fan switch to ON
4. Ensure the wireless controller is paired (page 9) with the heater
5. Set the thermostat to the desired temperature
6. Set the left hand switch to ON (switch illuminates)
  - A. If you require a faster warm up, for 2kW set the right hand switch only to ON (switch illuminates)
  - B. For 3kW heat output press both switches (switches illuminate)
7. Press the wireless controller ON switch up to four times. The display will indicate the running time of the heater. If the heater reaches the desired temperature during the running time, it will switch off.
8. To turn the heater OFF, set the controller switch to off (heating symbol not shown on display). Press the controller ON switch up to four times.

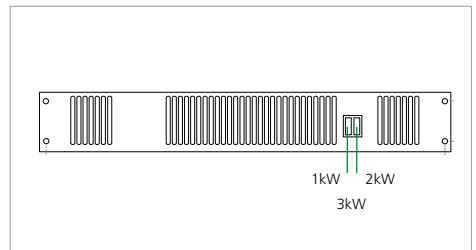

# How to operate

## SS80E

### Basic setting enabled

1. Ensure your fused spur is switched ON
2. Ensure the wireless controller is switched ON
3. Ensure the wireless controller is paired (page 9) with the heater
4. Set the thermostat to the desired temperature
5. Switch the upper fan switch to ON
6. Set the middle switch 600W to ON
7. If you require a faster warm up, also set the lower 1200W switch to ON

Please note all switches must be in the ON position to achieve 1200W output

8. To turn the heater OFF, set the controller switch to off (heating symbol not shown on display)

For your safety this Kitchen Heater is fitted with an automatic overheat protection. If the heater stops, turn off the power at the fused spur, wait 5 minutes and switch the power back on.

#### Air Circulation (Summer use)

Set the thermostat to maximum set the fan switch to ON ensure the 600W and 1200W switches are set to OFF. Space Saver will provide a cooling flow of air.

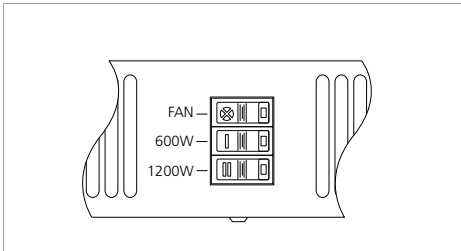

### Temperature control for Comfort (COMF) enabled

1. Ensure your fused spur is switched ON
2. Ensure the wireless controller is switched ON
3. Switch the upper fan switch to ON
4. Ensure the wireless controller is paired (page 9) with the heater
5. Set the thermostat to the desired temperature up to the maximum set during the installation process
6. Set the middle 600W switch to ON
7. If you require a faster warm up, also set the lower 1200W switch to ON

Please note all switches must be in the ON position to achieve 1200W output

8. To turn the heater OFF, set the controller switch to off (heating symbol not shown on display)

For your safety this Kitchen Heater is fitted with an automatic overheat protection. If the heater stops, turn off the power at the fused spur, wait 5 minutes and switch the power back on.

#### Air Circulation (Summer use)

Set the thermostat to maximum set the fan switch to ON ensure the 600W and 1200W switches are set to OFF. Kitchen Heater will provide a cooling flow of air.

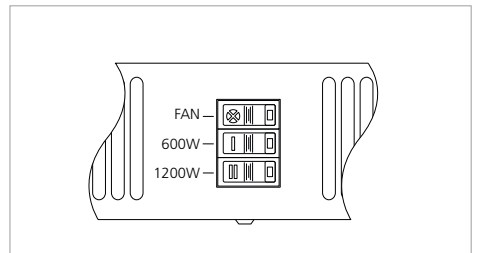

## Temperature control for Comfort (COMF) and Temperature control for Setback (SETB) enabled

1. Ensure your fused spur is switched ON
2. Ensure the wireless controller is switched ON
3. Switch the upper fan switch to ON
4. Ensure the wireless controller is paired (page 9) with the heater
5. Set the thermostat to the desired temperature up to the maximum set during the installation process
6. Set the middle 600W switch to ON
7. If you require a faster warm up, also set the lower 1200W switch to ON

Please note all switches must be in the ON position to achieve 1200W output

8. If the temperature falls below the minimum temperature set (SETB) during installation the heater will switch ON automatically
9. To turn the heater OFF, set the wireless controller switch to off (heating symbol not shown on display)

For your safety this Kitchen Heater is fitted with an automatic overheat protection. If the heater stops, turn off the power at the fused spur, wait 5 minutes and switch the power back on.

### Air Circulation (Summer use)

Set the thermostat to maximum set the fan switch to ON ensure the 600W and 1200W switches are set to OFF. Kitchen Heater will provide a cooling flow of air.

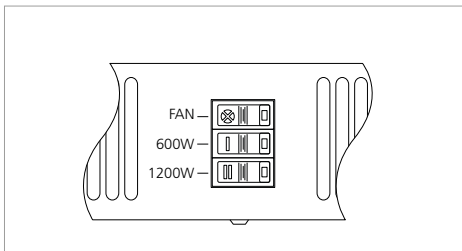

## How to operate – Run back Timer mode enabled

1. Ensure your fused spur is switched ON
2. Ensure the wireless controller is switched ON
3. Switch the upper fan switch to ON
4. Ensure the wireless controller is paired (page 9) with the heater
5. Set the thermostat to the desired temperature
6. Set the middle 600W switch to ON
7. If you require a faster warm up, also set the lower 1200W switch to ON

Please note all switches must be in the ON position to achieve 1200W output

8. Press the wireless controller ON switch up to four times. The display will indicate the running time of the heater. If the heater reaches the desired temperature during the running time, it will switch off
9. To turn the heater OFF, set the wireless controller switch to off (heating symbol not shown on display)

For your safety this Kitchen Heater is fitted with an automatic overheat protection. If the heater stops, turn off the power at the fused spur, wait 5 minutes and switch the power back on.

### Air Circulation (Summer use)

Set the thermostat to maximum set the fan switch to ON ensure the 600W and 1200W switches are set to OFF. Kitchen Heater will provide a cooling flow of air.

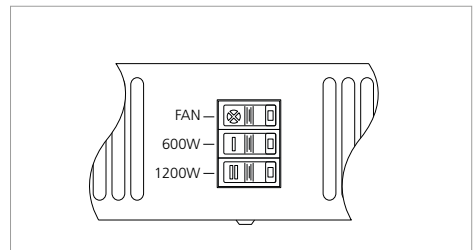

# How to operate

## SS5 DUAL

### Basic setting enabled

1. Set the upper rocker switch on the fascia grille to the right (blue) and the lower switch to the left or right - the fan should run
2. Set the upper rocker switch to the left (red) and the middle rocker switch to the right (electric heating). Heat will start to flow immediately. Increasing the fan speed will not increase the heat output in the electric heating mode
3. Turn on the central heating system
4. Set the room thermostat to maximum
5. Set the upper rocker switch to the left (red), the middle rocker switch to the left (hydronic heating) and the lower switch to the left (normal output). The fan should run and heat will flow within a few minutes
6. Balance the central heating system if Space Saver is installed on the same circuit as panel radiators
7. When the installation is working correctly, remember to reset any thermostat(s) to their normal setting

### Air Circulation (Summer use)

Set the thermostat to maximum. Ensure your central heating system is off. Set the upper switch to BLUE and the lower switch to (I) or (II). Space Saver will run to provide a flow of air.

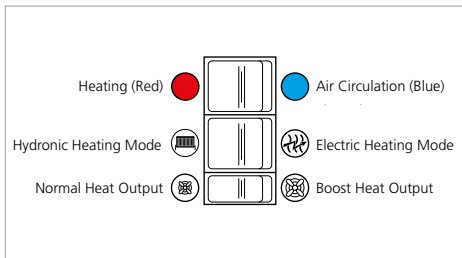

### Temperature control for Comfort (COMF) enabled

1. Ensure your fused spur is switched ON
2. Ensure the wireless controller is switched ON
3. Ensure the wireless controller is paired (page 9) with the heater
4. Set the thermostat to the desired temperature up to the maximum set during the installation process
5. Set the upper rocker switch on the fascia grille to the right (blue) and the lower switch to the left or right - the fan should run
6. Set the upper rocker switch to the left (red) and the middle rocker switch to the right (electric heating). Heat will start to flow immediately. Increasing the fan speed will not increase the heat output in the electric heating mode
7. Turn on the central heating system
8. Set the upper rocker switch to the left (red), the middle rocker switch to the left (hydronic heating) and the lower switch to the left (normal output). The fan should run and heat will flow within a few minutes
9. Balance the central heating system
10. To turn the heater OFF, set the controller switch to off (heating symbol not shown on display)

For your safety this Space Saver heater is fitted with automatic overheat protection. If the heater stops turn off the power at the fused spur and wait 5 minutes and switch the power back on.

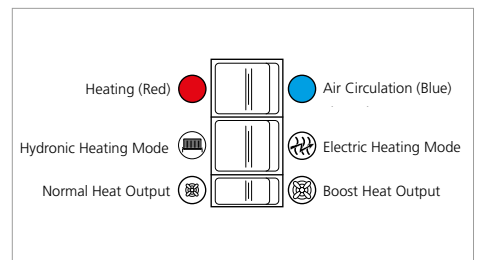

Note: If the central heating comes on whilst the Space Saver is switched to electric heating mode, the element will automatically switch off. Using Hydronic heating mode where possible will considerably reduce running costs.



## Temperature control for Comfort (COMF) and Temperature control for Setback (SETB) enabled

1. Ensure your fused spur is switched ON
2. Ensure the wireless controller is switched ON
3. Switch the upper fan switch to ON
4. Ensure the wireless controller is paired (page 9) with the heater
5. Set the thermostat to the desired temperature up to the maximum set during the installation process
6. Set the heater switches to the desired setting (hydronic or electric heating mode)
7. If the temperature falls below the minimum temperature set (SETB) during installation the heater will switch ON automatically
8. To turn the heater OFF, set the wireless controller switch to off (heating symbol not shown on display)

For your safety this Kitchen Heater is fitted with an automatic overheat protection. If the heater stops, turn off the power at the fused spur, wait 5 minutes and switch the power back on.

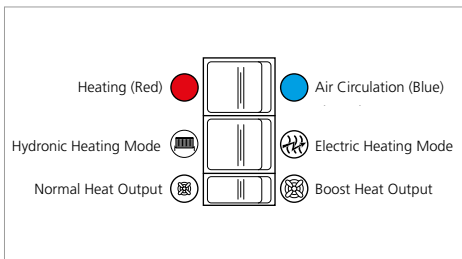

## How to operate – Run back Timer mode enabled

1. Ensure your fused spur is switched ON
2. Ensure the wireless controller is switched ON
3. Ensure the wireless controller is paired (page 9) with the heater
4. Set the thermostat to the desired temperature up to the maximum set during the installation process
5. Set the heater switches to the desired setting (hydronic or electric heating mode)
6. Press the wireless controller ON switch up to four times
7. The display will indicate the running time of the heater. If the heater reaches the desired temperature during the running time, it will switch off
8. To turn the heater OFF, set the controller switch to off (heating symbol not shown on display). Press the controller ON switch up to four times

For your safety this Kitchen Heater is fitted with an automatic overheat protection. If the heater stops, turn off the power at the fused spur, wait 5 minutes and switch the power back on.

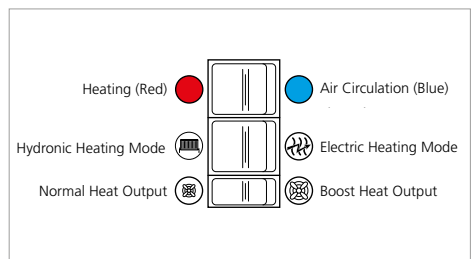

Note: If the central heating comes on whilst the Space Saver is switched to electric heating mode, the element will automatically switch off. Using Hydronic heating mode where possible will considerably reduce running costs.

# Fault finding

This Space Saver is covered by a free 5-year parts and labour guarantee.

Please refer to the Fault finding table below for advice.

In the event of difficulty, please contact us on +44 (0) 1245 324560.

Fault	Checking/Solution
Fan does not run/no heat output	<p>Check the power supply is switched ON</p> <p>Check fuse in fused spur</p> <p>Check the fan switch is set to ON</p> <p>Check the battery in the controller and replace if necessary</p> <p>Check the wireless controller thermostat is calling for heat</p> <p>Check the thermostat and controller is paired to the heater</p>
Fan does not run/no heat output on central heating mode (SS5 Dual only)	<ol style="list-style-type: none"> <li>1. If possible check that both of the copper pipes on the side of the unit are hot</li> <li>2. Ensure the flexible connections are not kinked</li> <li>3. Balance the central heating system if installed on the same circuit as panel radiators and increase the circulating pump speed if required</li> <li>4. Increase the boiler water temperature</li> <li>5. Check the service valves are open</li> <li>6. Bleed air from the appliance</li> </ol>
If the overheat protection has activated, manual reset as follows:	<ol style="list-style-type: none"> <li>1. Switch the power supply OFF at the fused spur</li> <li>2. Wait 5 minutes for the overheat cut-out switch to reset</li> <li>3. Switch the power supply on</li> </ol>

## Wireless Controller Self Diagnostic

The controller is equipped with a self diagnostic software that will check functionality of all main components. If there is a fault with any part of the controller or controller is operating outside of the temperature limits, the display will show 'Err' on the display. If this happens, controller will not function in order to protect itself and the heaters.

# Registering your product

Thank you for purchasing a Smith's product. It has been designed and manufactured to the highest quality standards to ensure it gives you efficient and trouble-free service for many years. To back up our commitment, included with your product is the following warranty:

## 5 years from date of purchase

This gives you the peace of mind that in the unlikely event of product failure, we will repair or replace the product completely free of charge providing the product has been installed, used and maintained in accordance with the instructions. Your statutory rights are not affected by this warranty.

It is important to register as soon as possible online at: [smithsep.co.uk/product-registration/](http://smithsep.co.uk/product-registration/). This will ensure you will receive prompt and efficient service if your product requires attention within the warranty period. If you do not register your product, you will be required to produce proof of purchase prior to receiving service.

For more details please visit our website: [SmithsEP.co.uk](http://SmithsEP.co.uk)

# Disposal

As part of the policy of continuous product improvement, Smith's Environmental Products LTD reserves the right to alter specification without prior notice.

Products with this symbol (crossed out wheellie bin) cannot be disposed as household waste. Old electrical and electronic equipment must be recycled at a facility capable of handling these products and their waste by-products. If you are purchasing replacement equipment your retailer may offer a 'take back' scheme, or will be able to give details of the nearest approved authorised treatment facility. Proper recycling and waste disposal will help conserve resources whilst preventing detrimental effects on our health and the environment.

WEEE Registered Code: WEE/ED0093VW



Approved CQS ISO  
9001:2015



ISO 14001  
Certificate No. 202200000

# After sales and spares

If you experience any problems with the use of your product, please contact our after-sales office +44 (0) 1245 324560.

For product information, customer services or sales support call us on +44 (0) 1245 324900

For the Republic of Ireland, contact MT Agencies on 01 864 3363

Sales: [sales@SmithsEP.co.uk](mailto:sales@SmithsEP.co.uk)

General information: [info@SmithsEP.co.uk](mailto:info@SmithsEP.co.uk)

Smith's Environmental Products Ltd  
Blackall Industrial Estate, South Woodham Ferrers,  
Chelmsford, Essex CM3 5UW

[SmithsEP.co.uk](http://SmithsEP.co.uk)

[@SmithsEP\\_UK](https://twitter.com/SmithsEP_UK)

[#ThinkSmiths](https://www.facebook.com/ThinkSmiths)



### **Happy to help**

Smith's Environmental Products Ltd is one of the leading manufacturers of heating and cooling products in the UK. We are committed to achieving the highest standards and our faith is supported by a free five year parts and labour guarantee with every product. Our customer service is second to none and we are happy to offer any help and guidance that you might need.

### **Stockists**

All products are available nationally from Builders' Merchants, Plumbers' Merchants, Heating Equipment Distributors and Kitchen Equipment Distributors. In the event of difficulty, please contact us or visit our website [SmithsEP.co.uk](http://SmithsEP.co.uk) for details of your nearest stockist.

### **Information and advice**

Full technical specifications and list prices is available to download from our website or in hard copy from our office. Also available on our website are price lists, individual product data sheets, installation & user guides, where to buy, who to contact and a media centre.

Alternatively contact our office 9.00am to 5.00pm Monday to Friday.

As part our commitment to continuous improvement Smith's Environmental Products may change the specifications of its products without prior notification or public announcement. All descriptions, illustrations, drawings and specifications in this publication present only general particulars and shall not form part of any contract. All dimensions are in mm unless otherwise stated.

**To view the full product information  
download the datasheet at:  
[www.SmithsEP.co.uk](http://www.SmithsEP.co.uk)**

For product information, customer services or sales support call us on **+44 (0) 1245 324900**

For the Republic of Ireland, contact MT Agencies on 01 864 3363

**Sales: [sales@SmithsEP.co.uk](mailto:sales@SmithsEP.co.uk)  
General information: [info@SmithsEP.co.uk](mailto:info@SmithsEP.co.uk)**

Smith's Environmental Products Ltd  
Blackall Industrial Estate, South Woodham Ferrers,  
Chelmsford, Essex CM3 5UW

**[SmithsEP.co.uk](http://SmithsEP.co.uk)**

**[@SmithsEP\\_UK](https://twitter.com/SmithsEP_UK)**

**[#ThinkSmiths](https://www.facebook.com/ThinkSmiths)**

Issue 002 | April 2019